

CATALOGO  
GENERALE

**LEGAR**

2021 - 2022

Le riproduzioni fotografiche, i colori, le caratteristiche proposte su questo catalogo possono non corrispondere esattamente alle versioni commercializzate. Ci riserviamo il diritto di apportare modifiche agli articoli senza alcun obbligo di preavviso alla clientela. E' vietata la riproduzione anche parziale del presente catalogo senza specifica autorizzazione della Legar Sport.





**ORDINI CLIENTI**  
clienti@legar.it



**WEB**  
www.legarshop.it



**INSTAGRAM**  
legarsport



Articolo disponibile fino ad esaurimento scorte  
This article is available while stock lasts



Trasporto al costo  
Transport freights on customer

Gentilissimi Clienti,

Benvenuti nel nuovo catalogo LEGAR SPORT 2021/2022, il vostro fornitore unico per oltre 1000 articoli, grazie all'ampiezza della gamma ed alla facilità di consultazione vi sarà facile trovare il prodotto che state cercando.

Al resto penseremo noi con un servizio di qualità.

I nostri clienti sanno che possono contare su di noi per le seguenti ragioni:

□ VELOCITÀ DI CONSEGNA

I prodotti sono sempre a magazzino per consegne immediate

□ OTTIMO RAPPORTO QUALITÀ PREZZO

Ogni prodotto è il frutto di una accurata selezione di mercato

□ FACILITÀ D'ORDINE

Basta un fax, una mail o meglio ancora utilizzare il nostro B2B

Il miglior modo per approfittare dei nostri servizi è provarli subito.

Contattateci per iniziare una collaborazione duratura nel tempo.

Leonardo Gardoni

Borse	<b>08</b>	<i>Bags</i>
Maglie	<b>12</b>	<i>T-Shirts</i>
Calze	<b>20</b>	<i>Socks</i>
Numeri & Stampe	<b>22</b>	<i>Numbers &amp; Printings</i>
Attrezzatura	<b>24</b>	<i>Equipment</i>
Corner	<b>36</b>	<i>Corner</i>
Borracce	<b>38</b>	<i>Water bottles</i>
Contenitori & Portapalloni	<b>42</b>	<i>Balls container</i>
Compressori & Pompe	<b>44</b>	<i>Balls pump</i>
Carrelli segnacampo	<b>46</b>	<i>Line markers</i>
Arbitro	<b>48</b>	<i>Referee</i>
Materassini & Stuoie	<b>52</b>	<i>Mats</i>
Potenziamento muscolare	<b>56</b>	<i>Muscle strengthening</i>
Pesistica	<b>60</b>	<i>Weights</i>
Fitness	<b>66</b>	<i>Fitness</i>
Accessori persona	<b>70</b>	<i>Personal accessories</i>
Tacchetti	<b>76</b>	<i>Studs</i>
Panchine	<b>86</b>	<i>Sport benches</i>
Calcio	<b>88</b>	<i>Soccer</i>
Portiere	<b>102</b>	<i>Goalkeeper</i>
Volley	<b>104</b>	<i>Volleyball</i>
Basket	<b>110</b>	<i>Basketball</i>
Pallamano	<b>116</b>	<i>Handball</i>
Ginnastica	<b>120</b>	<i>Gymnastic</i>
Atletica	<b>122</b>	<i>Athletics</i>
Badminton	<b>128</b>	<i>Badminton</i>
Tennis	<b>130</b>	<i>Tennis</i>
Ping pong	<b>132</b>	<i>Ping pong</i>
Hockey	<b>133</b>	<i>Hockey</i>
Beach	<b>134</b>	<i>Beach</i>
Tribune	<b>136</b>	<i>Grandstands</i>
Protezioni di sicurezza	<b>138</b>	<i>Protections</i>
Arredamento spogliatoio	<b>142</b>	<i>Dressing room</i>
Medical	<b>146</b>	<i>Medical</i>

**A**

Aghi	44
Antenne volley	104
Arbitro	48
Arco di precisione	28
Aste	24

**B**

Badminton	128
Ball-catcher	108
Banda resistenza	57
Bandierine corner	36
Bandierine guardialinee	51
Barella	153
Barriere	34
Basi per paletti	25
Bermuda microfibra	15
Berretto	18
Bilancia	145
Blocchi partenza	120
Blocco numeri	48
Borchie	84
Borracce	38
Borse	8
Borse zavorrate	60

**C**

Calcio-tennis	31
Calcio golf	33
Calze	20
Calzoncini	16
Canestri	114
Canotte basket	12
Carrelli portapalloni	42
Carrelli segnacampo	46
Casacche allenamento	18
Cavigliere	61
Cerchi piatti	30
Cerchi tubolari	121
Cestello portaborracce	38
Cestoni	42
Ciabatte	71
Cinesini	27
Clavette ritmica	120
Compressori	45
Conchiglia	70
Coni	26
Contametri	123
Contenitori	42
Corde ritmica	120
Corde salto	56
Corner	36
Cronometri	49
Cuffia invernale	18

**D**

Delimitatori	27
Dischi ghisa	65
Dischi lancio	125
Dischi piatti	27

**E**

Elastici fitness	68
Elastici potenziamento	57

**F**

Farmaceutica	146
Fasce capitano	19
Fischio arbitro	50
Fodere materassi	127
Fondi	11
Forca	30
Foot golf	33
Frattini	18
Frecce basket	115

**G**

Ganci porte	91
Ghiacciaia	150
Giacche antivento	14
Ginocchiere	70
Grasso scarpe	74
Guanti invernali	18
Guanto palestra	65
Guardialinee kit	51

**H**

Hockey	133
--------	-----

**I**

Idropittura	46
Impianti basket	112
Impianti volley	107

**K**

Kinetic	149
Kway	14

**L**

Lacci scarpe	74
Lavagne basket	111
Lavagne calcio	90
Lavagne futsal	99
Lavagne handball	119
Lavagne volley	109
Lavascarpe	144
Lettino massaggio	145

**M**

Macchine segnacampo	46
Maglie	13
Maglie lana/cotone	18
Manometri	45
Manubri	64
Materassi palestra	126

Materassi portiere	102
Materassini	52
Materasso gym mat	121
Medicale	146
Megafono	51
Minicompressore	45
Minitennis	131
Minitrampolino	31
<b>N</b>	
Nastro ritmica	120
Numeri	23
<b>O</b>	
Ostacoli	28
Ostacoli atletica	122
<b>P</b>	
Palco arbitro volley	108
Paletti slalom	24
Pali corner	36
Pali tennis	131
Palla vibrata	63
Palle getto	124
Palle ginniche	66
Palle mediche	62
Palle ritmica	120
Palloni basket	110
Palloni calcio	88
Palloni con gancio	30
Palloni futsal	99
Palloni handball	116
Palloni volley	104
Panchine allenatori	86
Panchine spogliatoio	142
Pantaloncini	16
Paracadute	56
Paradenti	70
Parastinchi	91
Patch	22
Pece	119
Pedane con molle	121
Pedane propriocettive	54
Pettorine	18
Pilates	69
Ping pong	132
Plantari	72
Plifix	46
Poggiapiedi	71
Pompe a mano	44
Porte calcio/calchetto	92
Porte handball	118
Prodotti medicali	146

Protezioni sicurezza	138
Pulisci scarpe	144
<b>R</b>	
Racchette badminton	128
Rebounder	31
Reti protezione	97
Reti basket	114
Reti calcio	93
Reti portapalloni	43
Reti tennis	130
Reti volley	106
Ribaltine	92
Rotella metrica	123
Rotolo carta	145
Ruota per addominali	58
<b>S</b>	
Sagome	34
Scaldacollo	18
Scalette	25
Scaldamani / piedi	75
Scudetti termoadesivi	22
Segnaletica campo	30
Segnapunti basket	110
Segnapunti volley	105
Slitta	58
Solette	72
Sospensorio	70
Step	67
Stuoie	52
<b>T</b>	
Tabella cambio giocatore	49
Tabelloni basket	113
Tacchetti	76
Talloniera	72
Tavoletta propriocettiva	54
Telai portiere	103
Tendiscarpe	74
Tennis	130
Tennis tavolo	132
Testimoni	122
Toppe	22
Traliccio gioco testa	30
Trampolino	31
Tute	14
<b>V</b>	
Vernice campo	46
Volani	128
Vortex	123
<b>Z</b>	
Zaini	9

new

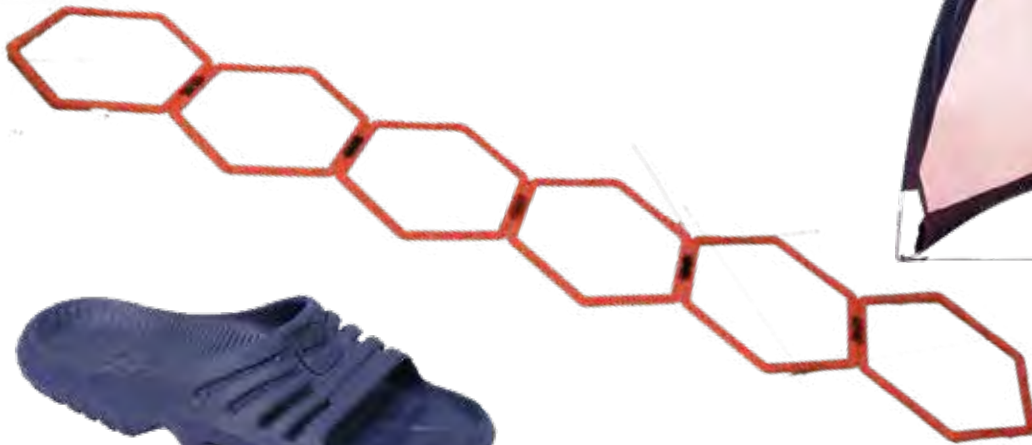

new

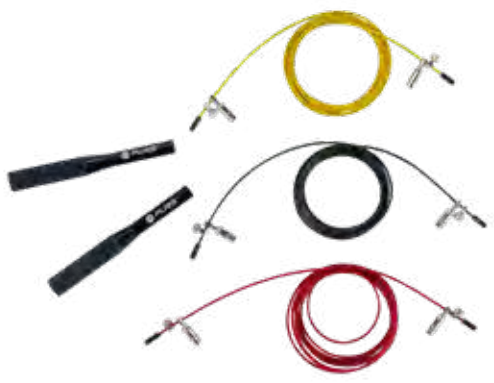

# 8 - borse



## BORSA PORTAMUTA

09 Blu

126002

€ 22,40 cad



1

cm 70x34x40h

ny



## BORSELLO MEDICAL

09 Blu

MB0040

€ 12,00 cad



1

cm 39x14x24h

ny



## BORSA MEDICAL PROF

09 Blu

MB0100

€ 24,00 cad



1

cm 41x21x29h

pl 600 D



new

## BORSA GYM

Tracolla regolabile imbottita  
Tasca portascarpe  
2 tasche interne  
Piedini gommati antiscivolo  
Cursori in alluminio

09 Blu

07 Nero

GB0010

€ 26,73 cad



1

cm 60x28x30h

pl 600 D

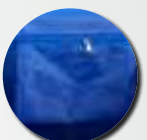
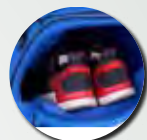

## ZAINO PROFIL

Doppio fondo 07 Nero  
 1 tasca interna 09 Blu  
 Schienale imbottito 08 Royal  
 Cursori in alluminio

Fondo escluso



BP0030

€ 16,66 cad



1

cm 34x24x48 h

pl 600 D

## ZAINO BICOL

Doppio fondo 770 Nero/Grigio  
 1 tasca interna 89 Royal/Blu  
 Schienale imbottito 49 Rosso/Blu  
 Cursori in alluminio

Fondo escluso



BP0020

€ 16,66 cad



1

cm 34x24x48 h

pl 600 D

## ZAINO CLASSIC

Doppio fondo 09 Blu  
 1 tasca frontale 04 Rosso  
 1 tasca interna 07 Nero  
 Piedini gommati antiscivolo 08 Royal  
 Cursori in alluminio

Fondo escluso



BP0010

€ 17,55 cad



1

cm 32x23x46h

pl 600 D

## FONDO ZAINO

Da utilizzare per zaino classi, profil e bicol



F11160

€ 2,48 cad



1

cm 33x23x11h

pp

**BORSA BIG**

Doppio fondo  
Tracolla regolabile  
Portanome  
1 tasca laterale  
Piedini gommati antiscivolo  
Rivestimento gommato ai manici  
Cursori in alluminio

08 Royal  
04 Rosso  
07 Nero  
09 Blu

Fondo escluso

SB1150

€ 22,95 cad

1

cm 53x32x49h

pl 600 D

**BORSA MEDIUM**

Doppio fondo  
Tracolla regolabile  
Portanome  
1 tasca laterale  
Piedini gommati antiscivolo  
Rivestimento gommato ai manici  
Cursori in alluminio

09 Blu  
08 Royal  
07 Nero  
04 Rosso

Fondo escluso

SB2130

€ 21,60 cad

1

cm 49x46x29h

pl 600 D

**BORSA BICOLOR BIG**

Doppio fondo  
Tracolla regolabile  
Portanome  
1 tasca laterale  
Piedini gommati antiscivolo  
Rivestimento gommato ai manici  
Cursori in alluminio

770 Nero/Grigio  
49 Rosso/Blu  
89 Royal/Blu

Fondo escluso

SB3150

€ 22,95 cad

1

cm 53x32x49h

pl 600 D



## FONDO GRANDE

Da utilizzare per borsa pol grande

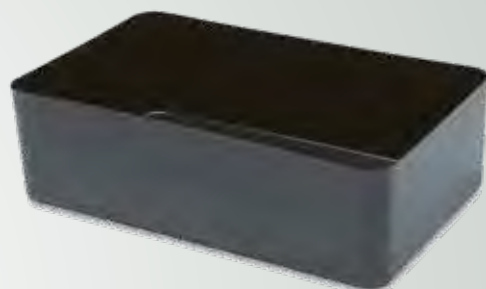

F15060

€ 3,78 cad

1

cm 52x32x15h

pp

## FONDO MEDIUM

Da utilizzare per borsa pol media

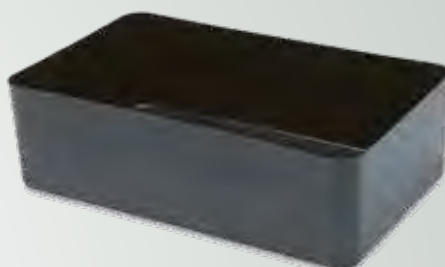

F11300

€ 3,78 cad

1

cm 49x29x13h

pp

## FONDO GRANDE

Da utilizzare per borsa pol grande



F15060

€ 3,78 cad

1

cm 52x32x15h

pp

## ZAINETTO EVERGREEN

- |    |            |    |       |
|----|------------|----|-------|
| 60 | Verde Fluo | 08 | Royal |
| 02 | Giallo     | 07 | Nero  |
| 03 | Arancio    |    |       |
| 40 | Fuxia      |    |       |
| 04 | Rosso      |    |       |
| 11 | Celeste    |    |       |
| 09 | Blu        |    |       |
| 01 | Bianco     |    |       |

OPG280

€ 2,21 cad

10

cm 33x45h

pl





**KIT BASKET DOUBLE**

Tessuto microforato  
Reversibile  
Pantaloncino con laccio in vita

Blu/bianco

ABK114

€ 20,00 cad

1

dalla 3YS alla 4XL

pl



**KIT BASKET DOUBLE**

Tessuto microforato  
Reversibile  
Pantaloncino con laccio in vita

Rosso/bianco

ABK154

€ 20,00 cad

1

dalla 3YS alla 4XL

pl



**KIT BASKET DOUBLE**

Tessuto microforato  
Reversibile  
Pantaloncino con laccio in vita

Royal/bianco



ABK124

€ 20,00 cad

1

dalla 3YS alla 4XL

pl

**KIT BASKET DOUBLE**

Tessuto microforato  
Reversibile  
Pantaloncino con laccio in vita

Blu/rosso

ABK115

€ 20,00 cad

1

dalla 3YS alla 4XL

pl



**KIT BASKET DOUBLE**

Tessuto microforato  
Reversibile  
Pantaloncino con laccio in vita

Nero/bianco

ABK134

€ 14,00 cad

1

dalla 3YS alla 4XL

pl



OUTLET  
solo per esaurimento scorte

## MAGLIA 57

Manica corta

Rosso/bianco/blu



A57514

€ 8,10 cad

5

da 3XS a XL

pl

## MAGLIA T02

Manica corta

Tessuto microforato  
Maglia multiuso  
Ideale come  
sopramaglia basket

Bianco



OUTLET  
fino al esaurimento scorte

AT0204

€ 7,60 cad

5

da 3XS a XL

pl

## MAGLIA 57

Manica corta

Verde/bianco/nero



A57734

€ 8,10 cad

5

da 3XS a XL

pl

## MAGLIA T02

Manica corta

Tessuto microforato  
Maglia multiuso  
Ideale come  
sopramaglia basket

Rosso



OUTLET  
fino al esaurimento scorte

AT0205

€ 7,60 cad

5

da 3XS a XL

pl

## MAGLIA 57

Manica corta

Royal/bianco/blu



A57214

€ 8,10 cad

5

da 3XS a XL

pl

## MAGLIA T02

Manica corta

Tessuto microforato  
Maglia multiuso  
Ideale come  
sopramaglia basket

Blu



OUTLET  
fino al esaurimento scorte

AT0201

€ 7,60 cad

5

da 3XS a XL

pl

## MAGLIA 57

Manica corta

Giallo/bianco/blu



A57614

€ 8,10 cad

5

da 3XS a XL

pl

## MAGLIA T02

Manica corta

Tessuto microforato  
Maglia multiuso  
Ideale come  
sopramaglia basket

Royal



OUTLET  
fino al esaurimento scorte

AT0202

€ 7,60 cad

5

da 3XS a XL

pl

TUTA MONACO

Pantalone con 2 tasche laterali  
Polso giacca, girovita  
e fondo pantalone  
con costina elasticizzata

09 Blu



A16101

€ 23,60 cad

1

da YS a 2XL

pl

TUTA MONACO

Pantalone con 2 tasche laterali  
Polso giacca, girovita  
e fondo pantalone  
con costina elasticizzata

07 Nero



A16103

€ 23,60 cad

1

da YS a 2XL

pl

GIACCA ANTIVENTO KIEV

Collo a V in costina

09 Blu



A16201

€ 11,78 cad

5

da 3XS a 2XL

pl

GIACCA ANTIVENTO KIEV

Collo a V in costina

07 Nero



A16203

€ 11,78 cad

5

da 3XS a 2XL

pl

### BERMUDA RELAX

Tessuto poliestere microfibra  
2 tasche laterali  
Taschino dietro con velcro  
Ribattiture in contrasto color bianco

07 Nero



A17103

€ 11,97 cad

1

da 3XS a 2XL

pl microfibra

### BERMUDA RELAX

Tessuto poliestere microfibra  
2 tasche laterali  
Taschino dietro con velcro  
Ribattiture in contrasto color bianco

09 Blu



A17101

€ 11,97 cad

1

da 3XS a 2XL

pl microfibra



### BERMUDA RELAX LUCIDO

Tessuto poliestere microfibra  
2 tasche laterali  
Taschino dietro con velcro  
Ribattiture in contrasto color bianco

07 Nero lucido

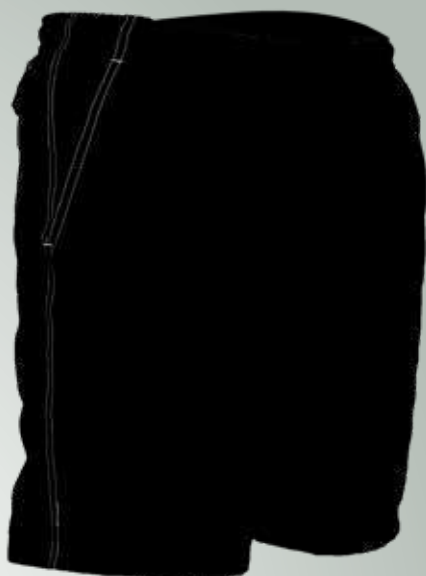

OUTLET  
fino al esaurimento scorte

A17103.LUCIDO

€ 9,77 cad

1

da 3XS a XL

pl microfibra

### BERMUDA RELAX LUCIDO

Tessuto poliestere microfibra  
2 tasche laterali  
Taschino dietro con velcro  
Ribattiture in contrasto color bianco

09 Blu lucido



OUTLET  
fino al esaurimento scorte

A17101.LUCIDO

€ 9,77 cad

1

da 2XS a 2XL

pl microfibra

PANTA 53 CLASSIC

4 pannelli  
Cordoncino in vita

01 Bianco



A53004

€ 4,31 cad

5

da 3XS a 2XL

pl

PANTA 53 CLASSIC

4 pannelli  
Cordoncino in vita

04 Rosso



A53005

€ 4,31 cad

5

da 3XS a 2XL

pl

PANTA 53 CLASSIC

4 pannelli  
Cordoncino in vita

05 Granata



A53008

€ 4,31 cad

5

da 3XS a 2XL

pl

PANTA 53 CLASSIC

4 pannelli  
Cordoncino in vita

06 Verde



A53007

€ 4,31 cad

5

da 3XS a 2XL

pl

PANTA 53 CLASSIC

4 pannelli  
Cordoncino in vita

08 Royal



A53002

€ 4,31 cad

5

da 3XS a 2XL

pl

PANTA 53 CLASSIC

4 pannelli  
Cordoncino in vita

07 Nero



A53003

€ 4,31 cad

5

da 3XS a 2XL

pl

PANTA 53 CLASSIC

4 pannelli  
Cordoncino in vita

09 Blu



A53001

€ 4,31 cad

5

da 3XS a 2XL

pl

## PANTA VOLLEY LADY

09 Blu



A16301

€ 8,50 cad

 1

da 2XS a 2XL

90% co 10% pl

## PANTA VOLLEY LADY

07 Nero



A16303

€ 8,50 cad

 1

da 2XS a 2XL

90% co 10% pl



# 18 - abbigliamento accessori

## CASACCA BIB

Tessuto liscio  
Misure man cm 54x64h  
Misure boy cm 46x52h

- 02 Giallo
- 03 Arancio
- 06 Verde
- 40 Fuxia
- 01 Bianco
- 08 Royal

206002

€ 3,50 cad

10

man - boy

pl



## SCALDACOLLO

Trasformabile in cappellino

- 09 Blu
- 07 Nero

21SC01

€ 2,80 cad

1

misura unica

pl



## CANOTTA BIS

Esterno lana  
Interno cotone

- 01 Bianco

21CN1V

€ 6,48 cad

3

da S a XL

co / wo



OUTLET  
fino al esaurimento scorte

## CUFFIA DOUBLE

Maglia pesante doppio strato

- 09 Blu
- 07 Nero

120961

€ 3,36 cad

10

misura unica

pc

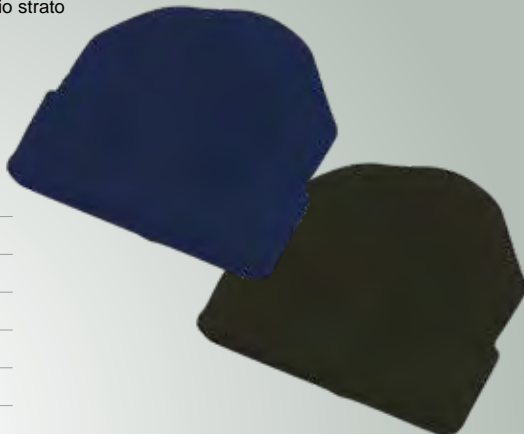

## MAGLIA BIS

Esterno lana  
Interno cotone

- 01 Bianco

000137

€ 10,75 cad

3

da S a XL

co / wo



## GUANTO POINT

Guanto elasticizzato  
Con gommatatura antiscivolo

- 09 Blu
- 07 Nero

21GU03

€ 3,64 cad

1

man - boy

90% pc 10% sp



### FASCIA CAPITANO "C"

Elasticizzata 20 Giallo  
 Elastico per facilitare 30 Arancio  
 posizionamento sul braccio 60 Verde  
 Velcro per la chiusura 01 Bianco  
 MAN: cm 33x6,5  
 BOY: cm 28x6,5



020001

€ 3,96 cad

1

man - boy

70% pl - 12% ny  
 18% el

### FASCIA CAPITANO MAN

Elasticizzata  
 Elastico per facilitare  
 posizionamento sul braccio  
 Velcro per la chiusura

02 Giallo  
 01 Bianco  
 04 Rosso  
 08 Royal

438000

€ 3,60 cad

1

cm 33x7,5

pl - ny - el



### FASCIA CAPITANO MAXI

Elasticizzata  
 Elastico per facilitare posizionamento sul braccio  
 Velcro per la chiusura  
 cm 33x9  
 Ideale per applicazioni scudetti e stampe

20 Giallo fluo  
 01 Bianco

170400

€ 3,58 cad

1

misura unica

80% pl 20%el



### FASCIA CAPITANO BOY

Elasticizzata  
 Elastico per facilitare  
 posizionamento sul braccio  
 Velcro per la chiusura

02 Giallo  
 01 Bianco  
 04 Rosso  
 08 Royal

437000

€ 3,60 cad

1

cm 28x5,5

70% pl - 12% ny  
 18% el



### FASCIA CAPITANO NEUTRA

Elasticizzata  
 Elastico per facilitare posizionamento sul braccio  
 Velcro per la chiusura  
 cm 33x7

08 Royal

140003

€ 2,20 cad

1

misura unica

80% pl 20%el



**OUTLET**  
 fino al esaurimento scorte

### FASCIA LUTTO

Elasticizzata  
 Elastico per facilitare posizionamento sul braccio  
 Velcro per la chiusura  
 cm 33x7

07 Nero

01FB01

€ 3,60 cad

1

misura unica

80% pl 20%el



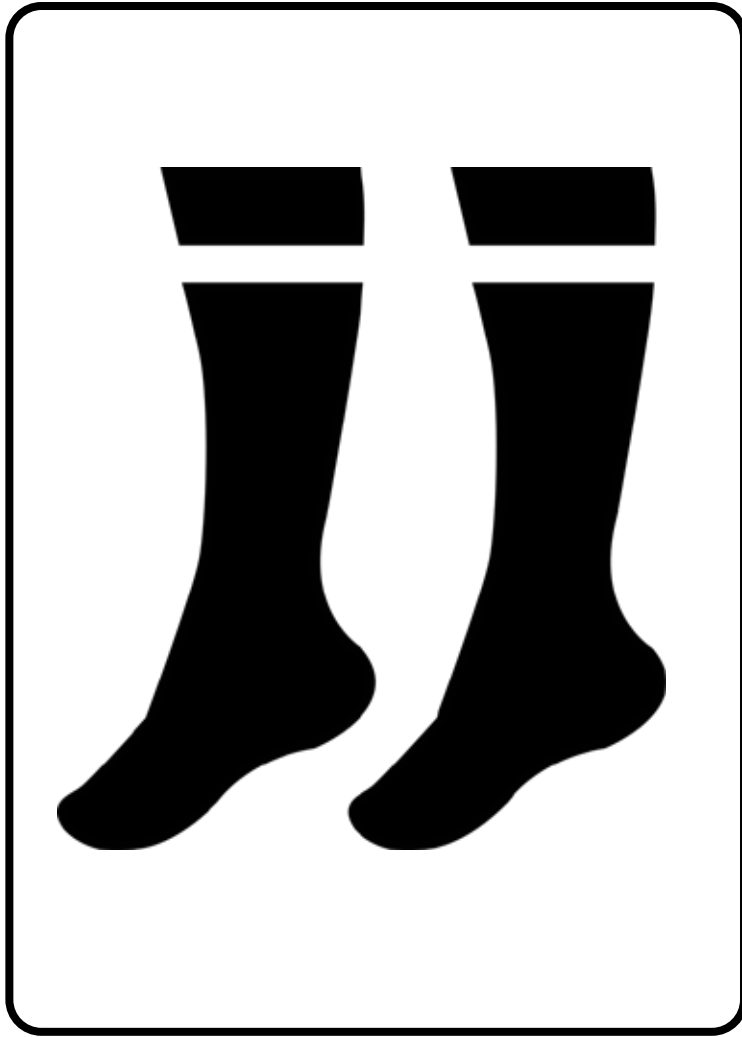

## CALZA BASKET

Tubolare

01 Bianco

109016

€ 3,36 paio

6

cm 67

71% co - 27% pa  
2% el

## CALZA VOLLEY

Tubolare

01 Bianco

109015

€ 2,56 paio

6

cm 45

71% co - 27% pa  
2% el

## NASTRO CALZASU

Nastro reggicalzettoni e parastinchi  
Adesivo01 Bianco  
02 Giallo  
04 Rosso  
05 Verde  
07 Nero  
08 Royal

027022

€ 3,90 cad

1

cm 2x25 mt

pvc



## CALZA ATHLETIC

Calza corta multiuso  
Piede cotone elasticizzato  
a pressione differenziata  
Per training, volley e relax01 Bianco  
04 Rosso  
07 Nero  
08 Royal  
09 Blu

001305

€ 2,85 paio

1

man - boy

55% pl 25% co  
15% pa 5% el

## CALZA AIR

Doppio risvolto  
e cavigliera elasticizzati  
Piede in cotone elasticizzato



22CA03

€ 2,93 paio

10

man - boy - kid

70% pl - 15% co  
15%el

## CALZA PRO

Doppio risvolto  
e cavigliera elasticizzati  
Piede in cotone elasticizzato



190300

€ 3,80 paio

1

man - boy - kid

80% pp - 20% co

## CALZA SHOCK

Doppio risvolto e cavigliera elasticizzati  
Piede in cotone elasticizzato  
a pressione differenziata

20 Giallo fluo  
60 Verde fluo  
30 Arancio fluo  
40 Fuxia



001501

€ 5,13 paio

1

man - boy

15% co - 82% pa  
3% el

## CALZA TUBO SENZA PIEDI

01 Bianco  
04 Rosso  
07 Nero  
08 Royal  
09 Blu



new

205800

€ 4,18 paio

10

man - boy - kid

70% pl - 15% co  
15%el

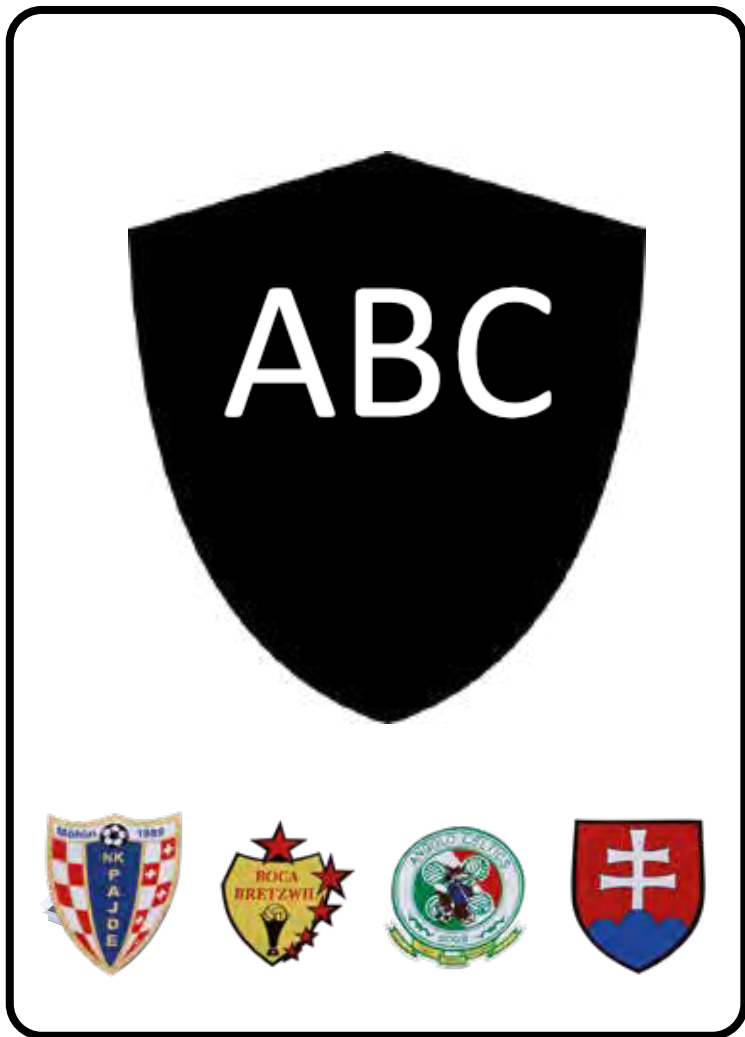

Patch da termosaldare  
con pressa automatica  
**15 secondi - 150°**

Misura massimo sviluppo  
**9 cm per lato**  
oltre chiedere preventivo

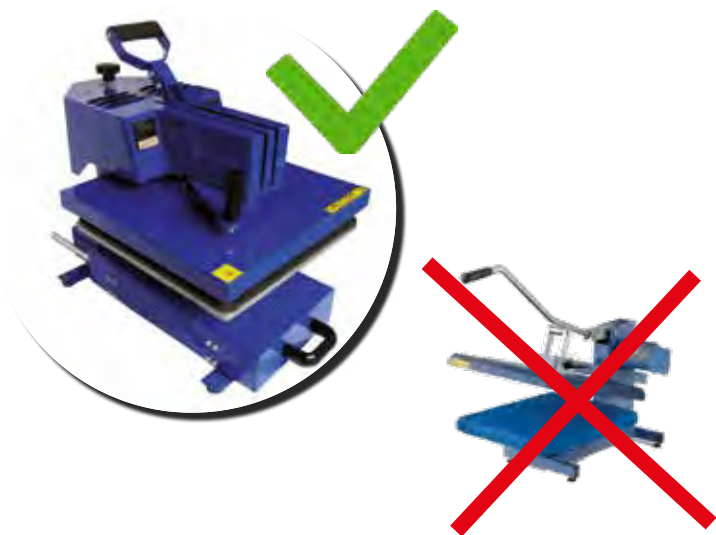

SCUDETTO HD TERMOADESIVO 300 PEZZI

La quantità può variare  
da 280 a 330 pezzi

Consegna in circa 20 giorni  
dalla data conferma bozza



100049

€ 2,02 cad

da 300 a 599

massimo sviluppo

cm 9 per lato

SCUDETTO HD TERMOADESIVO 600 PEZZI

La quantità può variare  
da 580 a 630 pezzi

Consegna in circa 20 giorni  
dalla data conferma bozza



100051

€ 1,70 cad

da 600

massimo sviluppo

cm 9 per lato

SCUDETTO HD TERMOADESIVO 1.000 PEZZI

La quantità può variare  
da 980 a 1.030 pezzi

Consegna in circa 20 giorni  
dalla data conferma bozza



100050

€ 1,44 cad

da 1000

massimo sviluppo

cm 9 per lato

BANDIERINA HD TRICOLORE



140001

€ 1,76 cad

1

cm 6,5 x 3,5

## SERIE NUMERO CLASSIC CM 23

Serie completa da 1 a 18

01 Bianco

1 2 3 4 5  
6 7 8 9 10  
11 12 13 14  
15 16 17 18

136001

€ 18,90 serie

1

cm 23

## SERIE NUMERO CLASSIC CM 23

Serie completa da 1 a 18

07 Nero

1 2 3 4 5  
6 7 8 9 10  
11 12 13 14  
15 16 17 18

136001

€ 18,90 serie

1

cm 23

## SERIE NUMERO CLASSIC CM 23

Serie completa da 1 a 18

08 Royal

1 2 3 4 5  
6 7 8 9 10  
11 12 13 14  
15 16 17 18

136001

€ 18,90 serie

1

cm 23

## SERIE NUMERO CLASSIC CM 23

Serie completa da 1 a 18

09 Blu navy

1 2 3 4 5  
6 7 8 9 10  
11 12 13 14  
15 16 17 18

136001

€ 18,90 serie

1

cm 23

## SERIE NUMERO CLASSIC CM 23

Serie completa da 1 a 18

04 Rosso

1 2 3 4 5  
6 7 8 9 10  
11 12 13 14  
15 16 17 18

136001

€ 18,90 serie

1

cm 23



## NUMERO CLASSIC SFUSO CM 9

01 Bianco  
07 Nero

1 2 3 4 5  
6 7 8 9 0  
1 2 3 4 5  
6 7 8 9 0

100013

€ 0,68 cad

1

cm 9



## NUMERO CLASSIC SFUSO CM 23

01 Bianco  
07 Nero  
08 Royal  
09 Blu

1 2 3 4 5  
6 7 8 9 0  
1 2 3 4 5  
6 7 8 9 0

100012

€ 1,22 cad

15

cm 23

1 2 3 4 5  
6 7 8 9 0  
1 2 3 4 5  
6 7 8 9 0



**PALO SLALOM TOP**

Altezza 170 cm + puntale

- 03 Arancio
- 08 Royal
- 01 Bianco
- 02 Giallo
- 04 Rosso



202017

€ 6,20 cad



12

h 170 - ø 32

pvc

**PALO SLALOM ECO**

Punta in acciaio

- 04 Rosso
- 02 Giallo

032893

€ 6,14 cad



1

h 160 - ø 25

pvc

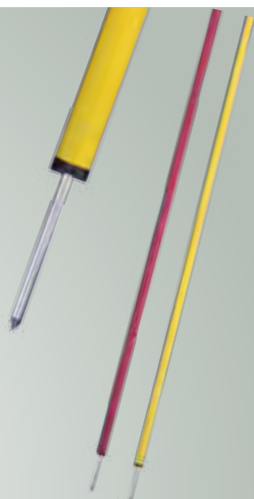

**ASTA CM 100**

Da utilizzare con coni forati, basi

- 02 Giallo
- 04 Rosso

033903

€ 3,13 cad



1

h 100 - ø 25

pvc



**CLIP GIREVOLE**

Da utilizzare per aste e pali  
Diametro 25

033502

€ 2,02 cad



1

ø 25

pp



**ASTA CM 160**

Da utilizzare con coni forati, basi

- 02 Giallo
- 04 Rosso

033301

€ 4,32 cad



1

h 160 - ø 25

pvc



## BASE CUPOLA

Da utilizzare per aste  
senza puntale diam. 25  
Cerchi piatti e tondi  
Riempibile con acqua o sabbia



334020

€ 8,10 cad

1

Ø 25

abs

## SCALA 10 PIOLI REGOLABILI

I pioli si possono regolare alla distanza desiderata  
Professionale

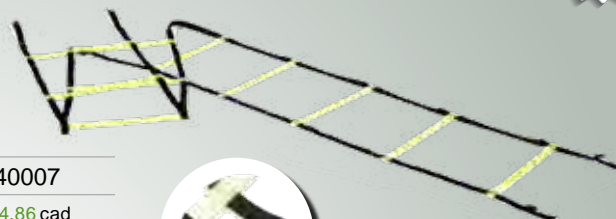

140007

€ 24,86 cad

1

mt 4

pvc



## BASE PIATTA

Per aste senza puntale e cerchi piatti  
Base con 2 diametri da 25 e 30  
Peso 600gr



033405

€ 12,10 cad

1

Ø 25/30

abs

## SCALA 9 PIOLI

Compresa di picchetti ancoraggio

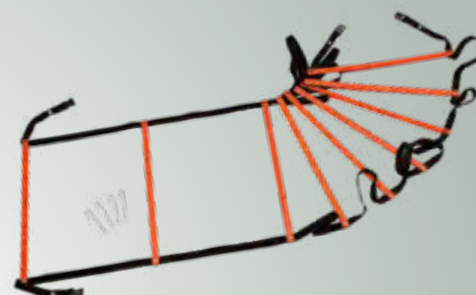

100531

€ 20,45 cad

1

mt 4x55 cm

## BASE PRO

Per aste senza puntale  
diametro 25



060001

€ 8,28 cad

4

Ø 25

pvc

## SCALA 10 PIOLI TONDI

Sacca compresa

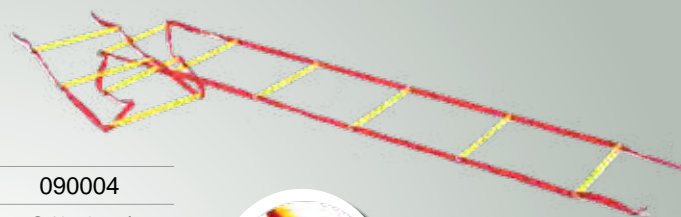

090004

€ 42,56 cad

1

mt 4x45 cm



## SCALA EXAGONAL MT 3

Esagonali agganciati con clip  
Possibile comporre varie forme per diversi esercizi  
Ogni esagono misura 50 cm  
Sacca inclusa

03 Arancio  
02 Giallo

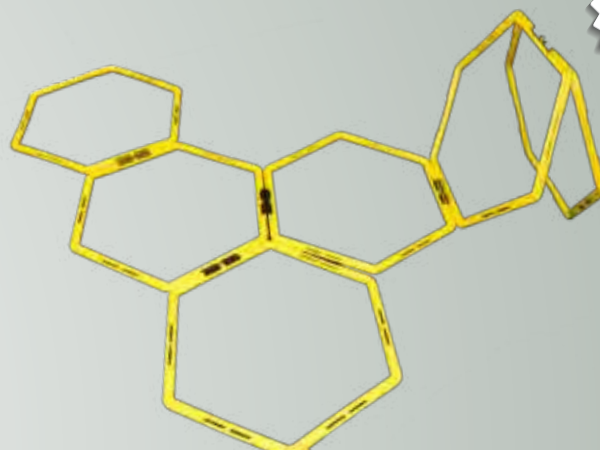
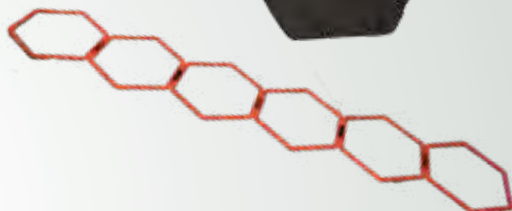

202306

€ 43,20 cad

1

mt 3

pvc

**CONO H30**

- 20 Giallo fluo
- 30 Arancio fluo
- 60 Verde fluo
- 08 Royal



032660

€ 5,36 cad

1

h 30

pe

**CONO FLESSIBILE H30 KIT 4 PZ**

Calpestabile  
Adatto per l'allenamento di bambini



TA0350

€ 21,06 kit

4

h 30

pvc

**CONO H30 FORATO**

12 fori per aste dia25  
Fessura porta cerchio

- 20 Giallo fluo
- 30 Arancio fluo
- 60 Verde fluo
- 08 Royal



032661

€ 5,74 cad

1

h 30

pe

**CONO CALPESTABILE H13**

Antifortunistico

- 02 Giallo
- 04 Rosso



172600

€ 3,84 cad

1

h 16

pvc

**CONO H50 FORATO**

16 fori per aste dia25  
Fessura porta cerchio

- 08 Royal
- 06 Verde
- 03 Arancio
- 02 Giallo



161118

€ 11,92 cad

1

h 50

pe

**CONO H30 KIT 12 PZ**

Con incavo per asta  
Sede per cerchio piatto



- 04 Rosso
- 02 Giallo



100046

€ 47,36 kit

1

h 30

pe



## DELIMITATORI KIT 48 - 2 COLORI

Kit 48 pz 24 per colore  
Giallo/Arancio



203023

€ 25,84 kit

	1
	h 5
	pp

## DELIMITATORI KIT 48 - 2 COLORI

Kit 48 pz 24 per colore  
Bianco/Royal



203018

€ 25,84 kit

	1
	h 5
	pp

## DELIMITATORI KIT 48 PZ - 4 COLORI

12 per colore Bianco/Arancio/Royal/Giallo



202300

€ 25,84 kit

	1
	h 5
	pp

## DELIMITATORI KIT 48 PZ

40 Fuxia  
08 Royal  
04 Rosso  
01 Bianco  
03 Arancio  
02 Giallo



150005

€ 25,84 kit

	1
	h 5
	pp

## DISCHI PIATTI KIT 24 PZ

Set di 24 dischi di delimitazione in gomma antiscivolo  
Adatti per l'allenamento dei passaggi e del dribbling  
Non interferiscono sulla traiettoria della palla  
Supporto metallico per il trasporto incluso  
12 gialli + 12 arancio



TA1390

€ 43,68 kit

	24
	ø 15 cm
	gomma flessibile

## DISCHI PIATTI DOUBLE KIT 9 PZ

Un lato giallo e un lato rosso  
Oppure un lato verde e uno blu



150481

€ 23,90 kit

	1
	ø 15 cm
	pvc

## DELIMITATORI GRANDI KIT 24 PZ

Delimitatori flessibili e resistenti  
adatti per diversi sport  
Diametro 30 cm

Raccoglitore incluso



TA0300

€ 48,60 kit

	1
	h 12
	plastica

## DISCHI PIATTI NUMERATI SPOTS TRAINER

Numerati da 1 a 10



390000

€ 40,79 kit

	1
---	---

## OSTACOLO FLESSIBILE H12

Pezzo unico  
Tubo flessibile ø 25  
Larghezza cm 75



106016

€ 13,64 cad



1

h 12

pvc



## OSTACOLO FERRO

Larghezza cm 78



000205

€ 22,37 cad



6

h 12, 18, 24, 30

ferro verniciato

## OSTACOLO FLESSIBILE H20

Pezzo unico  
Tubo flessibile ø 25  
Larghezza cm 75



106018

€ 15,31 cad



1

h 20

pvc

## OSTACOLO RICHIUDIBILE H30

Altezza regolabile  
da 0 a 30 cm  
Larghezza cm 79  
Tubo ø 30



G01320

€ 22,14 cad



1

h 30

pvc

## OSTACOLO FLESSIBILE H30

Pezzo unico  
Tubo flessibile ø 25  
Larghezza cm 75



106019

€ 16,07 cad



1

h 30

pvc

## OSTACOLO RICHIUDIBILE H60

Altezza regolabile  
da 0 a 60 cm  
Larghezza cm 79  
Tubo ø 30



G01350

€ 24,66 cad



1

h 60

pvc

## OSTACOLO FLESSIBILE H40

Pezzo unico  
Tubo flessibile ø 25  
Larghezza cm 75



106020

€ 18,39 cad



1

h 40

pvc

## ARCO DI PRECISIONE

Tubo flessibile regolabile  
in altezza e larghezza  
Punta in acciaio



032701

€ 25,60 cad



1

cm 30/80

pvc



## OSTACOLO BLANCO H20

Tubo ø 32



202520

€ 9,68 cad

1

cm 20x70

pvc

## OSTACOLO REGOLABILE H50

Regolabile in altezza da 30 a 50 cm  
Larghezza cm 80

000201

€ 30,82 cad

1

h 30/50

ferro verniciato



## OSTACOLO BLANCO H30

Tubo ø 32



202530

€ 11,10 cad

1

cm 30x70

pvc

## OSTACOLO REGOLABILE H90

Regolabile in altezza da 60 a 90 cm  
Larghezza cm 100

000202

€ 35,74 cad

1

h 60/90

ferro verniciato



## OSTACOLO BLANCO H40

Tubo ø 32



202540

€ 12,15 cad

1

cm 40x70

pvc

## OSTACOLO MATCH REGOLABILE

Regolabile in altezza da 10 a 60 cm  
Larghezza cm 80  
Tubo dia 30

033850

€ 25,76 cad

1

h 10 / 60

pvc

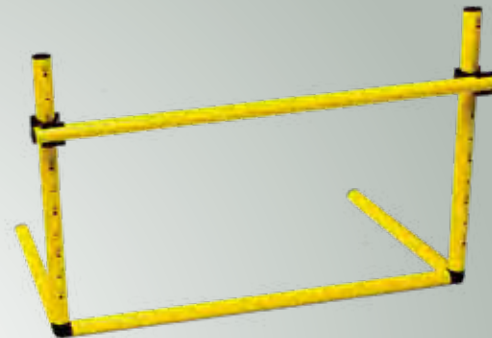

## OSTACOLO BLANCO H50

Tubo ø 32



202550

€ 13,05 cad

1

cm 50x70

pvc

## OSTACOLO BLANCO H60

Tubo ø 32



202560

€ 14,93 cad

1

cm 60x70

pvc

## CERCHIO PIATTO 50

06 Verde  
08 Royal  
02 Giallo  
04 Rosso

new

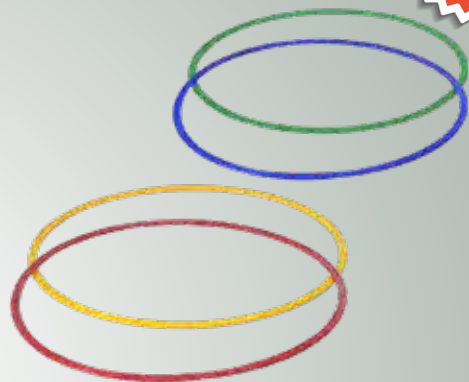

050050

€ 4,34 cad

5

ø 50

pvc

## TRALICCIO GIOCO TESTA

Per allenamento gioco calcio  
Altezza da terra mt 3  
Apertura totale mt 3  
Smontabile  
Compreso di bossola da interrare  
Esclusi corda e pallone

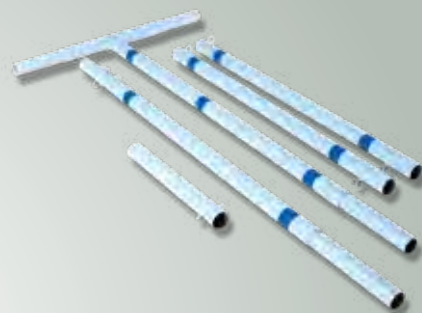

080203

€ 240,61 cad

1

mt 3x3

ferro verniciato

## CERCHIO PIATTO 60

06 Verde  
08 Royal  
02 Giallo  
04 Rosso

new

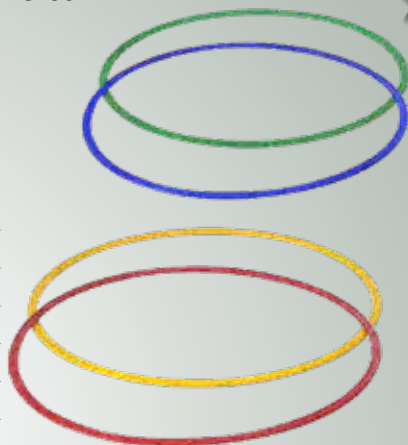

050060

€ 5,92 cad

5

ø 60

pvc

## PALLONE CON GANCIO

Per traliccio gioco testa



060119

€ 24,00 cad

1

misura 4

pvc

## CERCHIO PIATTO 70

06 Verde  
08 Royal  
02 Giallo  
04 Rosso

new

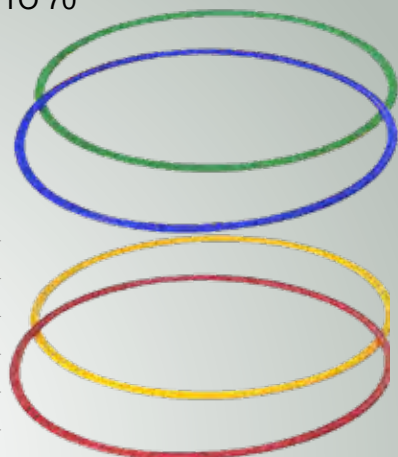

050070

€ 7,56 cad

5

ø 70

pvc

## CORDE PER TRALICCIO



060203

€ 13,88 cad

1

mt 6

corda

## KIT DELIMITAZIONE CAMPO

Per delimitare campi da gioco  
Da utilizzare in palestra  
Kit composto da:  
24 pezzi lineari cm 39,5  
Larghezza cm 4  
4 angoli  
Spessore 2 mm



019747

€ 24,13 kit

1

h 2 mm

pvc morbido

## PALLONE FORCA MIS 5

Pallone in gomma doppio strato  
Gr 420  
ø 21,5

new



211400

€ 33,60 cad

1

misura 5

gomma

## IMPIANTO TENNIS 400x90

Impianto tennis professionale  
Trasportabile  
In alluminio  
Con sacca per il trasporto



TE0064

€ 208,00 cad

1

cm 400x90 h

alluminio

## TRAMPOLINO



962000

€ 93,60 cad

1

ø 98 cm

## IMPIANTO CALCIO TENNIS

Con sacca  
Per tutte le superfici



032304

€ 97,20 cad

1

cm 300x90 h

ferro verniciato



## PANNELLO REBOUND

Pannello di rimbalzo in PVC utilizzabile sia all'interno che all'esterno e valido su ogni tipo di terreno  
Questo pannello permette la ripetizione di gesti tecnici e imprevedibili, indispensabili per l'allenamento di calcio



TA2060

€ 360,00 cad

1

cm 100x60 h

pvc

## IMPIANTO CALCIO TENNIS

Pali in pvc  
Rete mt 3,3  
Completo di tiranti  
e picchetti  
per terreni naturali

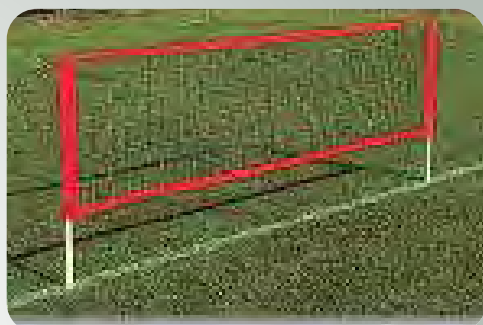

00013N

€ 103,50 cad

1

mt 3,3

pvc

## FISCHIO SYBIL

Per attività sportiva, outdoor e sicurezza personale  
2 tonalità + segnale SOS  
Igienico  
Ergonomico  
Batterie e cordino inclusi  
Durata batteria da 3 a 5 mesi



190700

€ 18,56 cad

1

## FOOTBALL FLICK

Prodotto innovativo per l'allenamento di calcio  
 Trainer tridimensionale e multiutente creato per migliorare le tattiche fondamentali del calcio  
 Permette ai giocatori di esercitarsi sui passaggi e di ricevere la palla ad altezze, velocità ed angoli diversi  
 Con il football flick c'è un controllo maggiore della palla e di precisione dei passaggi  
 Aumenta la reattività, la precisione e la rapidità nei tiri  
 Misure prodotto piegato: cm 110x74x7 h



TA1180

€ 230,40 cad

1

cm 137x74x72 h

pe



Un prodotto innovativo e polivalente creato per migliorare le tattiche fondamentali del calcio!  
 Trainer multiutente composto da una rampa curva, una rete rimbalzante e una rete raccogli palloni.

- Permette ai giocatori di esercitarsi sui passaggi e di ricevere la palla ad altezze e velocità diverse e da angoli diversi
- Aumenta la reattività, la precisione e la rapidità dei tiri
  - Materiale: struttura in acciaio ultra resistente
  - Include una borsa per il trasporto

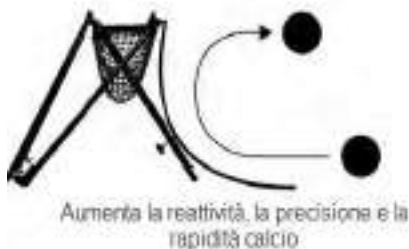

## TELAIO SOCCER REBOUNDER



150200

€ 131,18 kit

1

cm 113x61x106 h

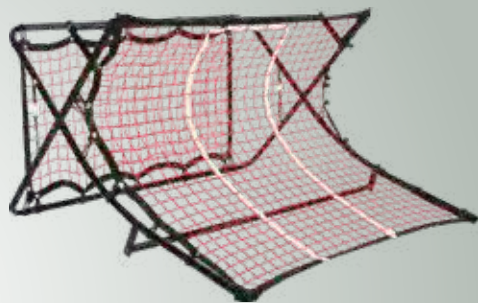

## FOOT GOLF KIT 3 BERSAGLI



Kit composto da 3 basi in schiuma  
+ 3 bandiere numerate da 1 a 3 + 3  
strutture per fissaggio base + 3 aste  
in fibra di vetro

FGE030

€ 302,40 kit

1



**SAGOMA GONFIABILE H 165 PER BAMBINI**

Sagoma utilizzabile per l'allenamento dei bambini  
Permette di effettuare una vasta gamma di esercizi  
Base riempibile con acqua o sabbia,  
la parte superiore si gonfia con una pompa  
Pratici manici laterali per permettere il trasporto  
Torna sempre nella posizione verticale iniziale  
PVC resistente all'acqua e anti-UV

Altezza 165 cm  
Base 60 cm  
Diametro 45 cm



903500

€ 71,20 cad

1

h 165

pvc

**SAGOMA GONFIABILE H 175**

Sagoma utilizzabile per l'allenamento di portieri e calciatori  
Permette di effettuare una vasta gamma di esercizi  
Base riempibile con acqua o sabbia, la parte superiore si gonfia con una pompa  
Pratici manici laterali per permettere il trasporto  
Torna sempre nella posizione verticale iniziale  
PVC resistente all'acqua e anti-UV

Kit di riparazione incluso



TA2080

€ 144,00 cad

1

h 175

pvc

**SAGOMA SOCCER WALL**

Ideale per simulare azioni da gioco  
Si può utilizzare con qualsiasi tipo di paletto o asta

Solo sagoma

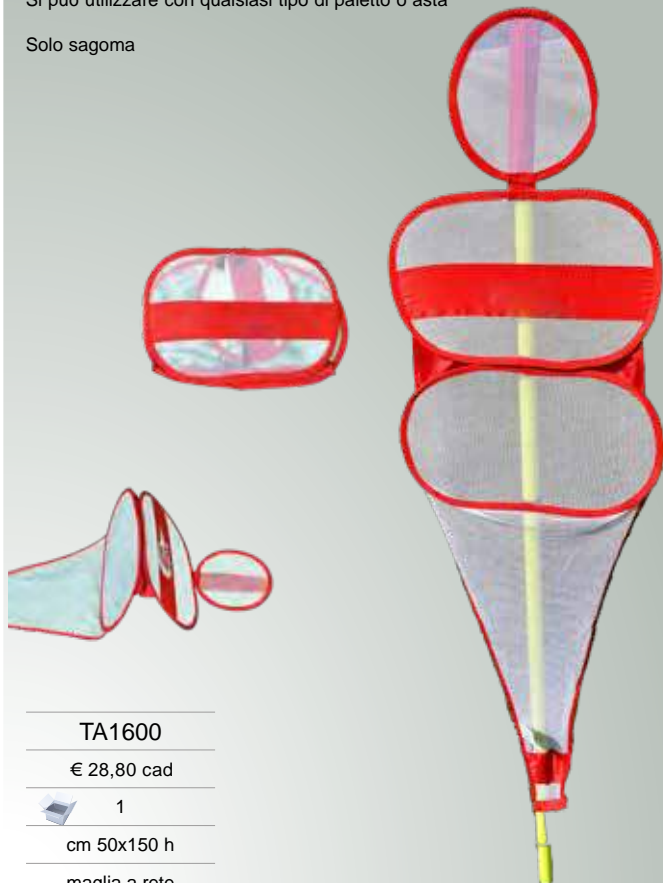

TA1600

€ 28,80 cad

1

cm 50x150 h

maglia a rete

**SAGOMA GONFIABILE H 205**

Sagoma utilizzabile per l'allenamento di portieri e calciatori  
Permette di effettuare una vasta gamma di esercizi  
Base riempibile con acqua o sabbia, la parte superiore si gonfia con una pompa  
Pratici manici laterali per permettere il trasporto  
Torna sempre nella posizione verticale iniziale  
PVC resistente all'acqua e anti-UV

Kit di riparazione incluso



TA2090

€ 160,00 cad

1

h 205

pvc

## SAGOMA SNODATA KIT 3 PZ

Ideali per l'allenamento e il perfezionamento dei calci di punizione  
Base esclusa



TA039S
€ 306,00 kit
3
h 182x60 cm
plastica e acciaio

## CARRELLO SAGOME 5 POSTI

Carrello trasportabile con ruote  
Ideale per terreni sintetici e naturali  
Da utilizzare per articolo TA039S e 202118

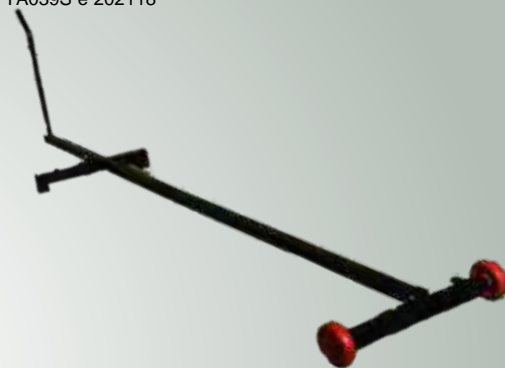

TA0420
€ 180,00 cad
1
acciaio zincato

## BASE PER SAGOMA

Base per sagoma  
Ideale per terreni sintetici, naturali e interni  
Da utilizzare per articolo TA039S e 202118

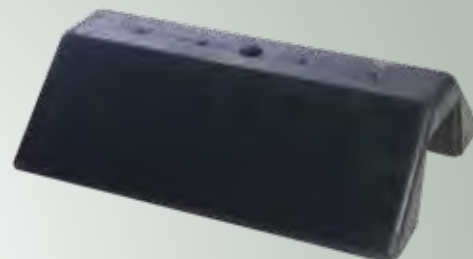

TA0410
€ 64,80 cad
1
kg 12
plastica dura

## SAGOMA PRO FKM 180

Flessibile

04 Rosso  
02 Giallo

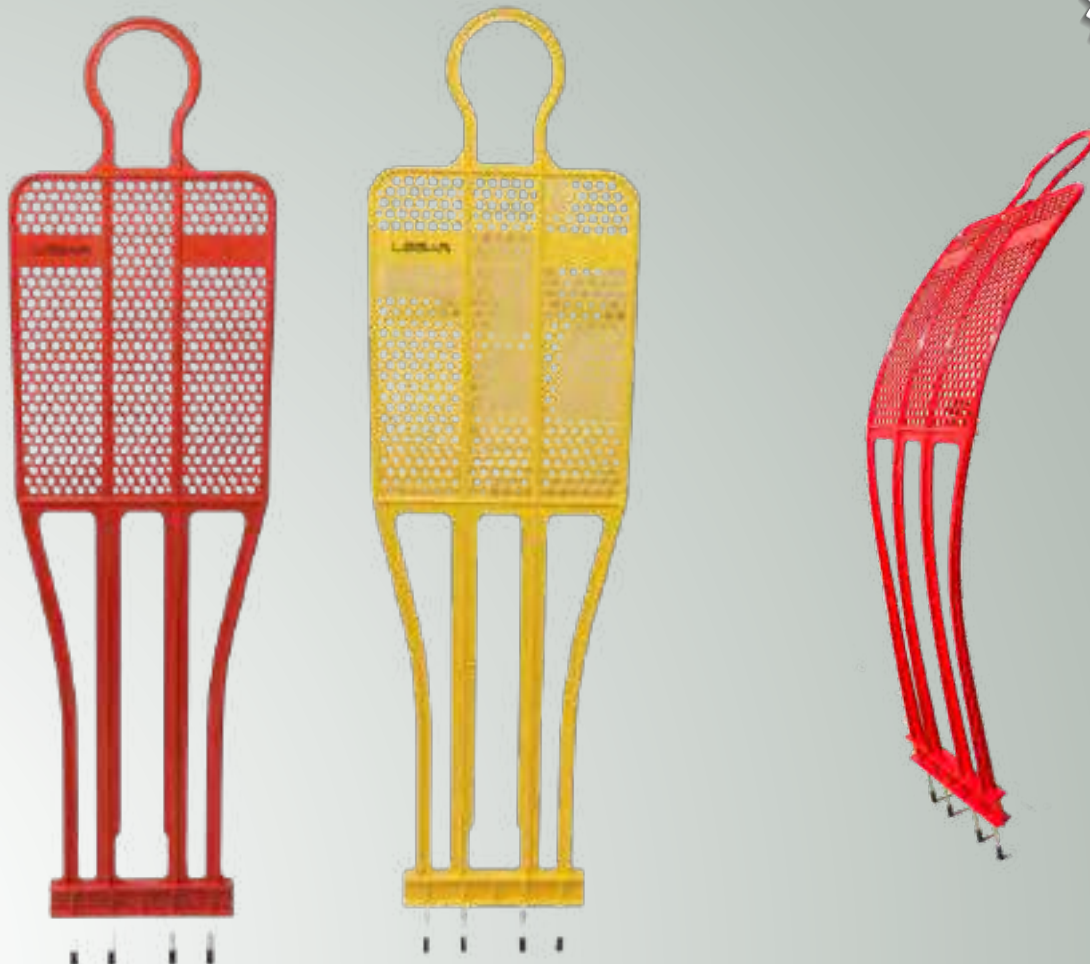

**new**

202118
€ 116,46 cad
1
h 180
pvc

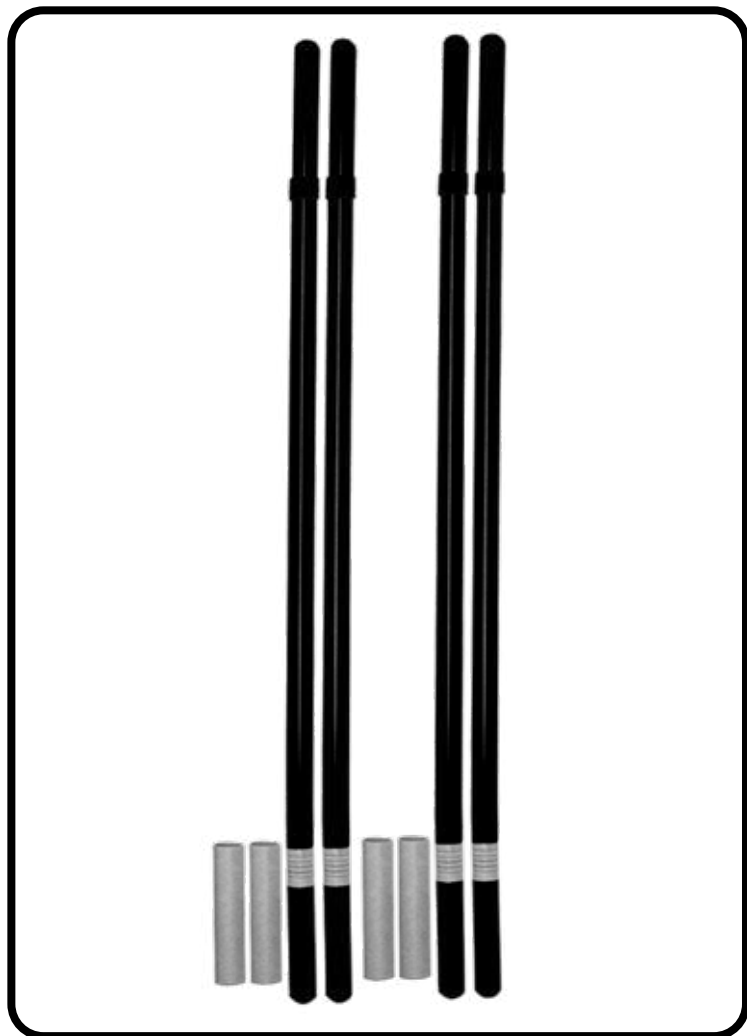

## KIT 4 BANDIERINE CORNER

030011

€ 18,00 kit



1

cm 60x40

ny

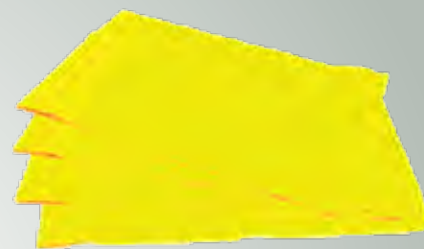

## CLIP FERMABANDIERINA CORNER

Per palo corner

030201

€ 0,65 cad



1

ø 30

pvc



## BOCCOLA DA INTERRARE

Per palo corner

030151

€ 2,27 cad



1

ø 30

pvc



## KIT CORNER PROFESSIONAL

Kit composto da:  
 4 pali ø 30 con snodo professionale  
 4 boccole da interrare  
 4 clip  
 4 bandierine

20 giallo fluo

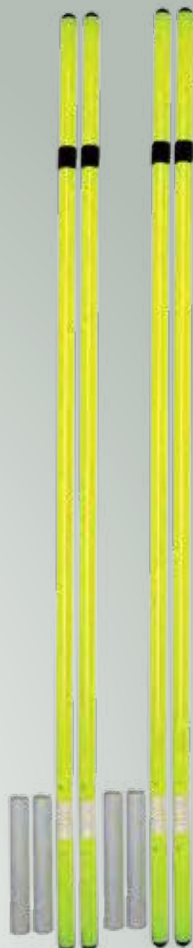

30052K

€ 119,59 kit



1

h 160 - ø 30

pvc

## KIT CORNER

Kit composto da:  
 4 pali ø 30 con snodo professionale  
 4 boccole da interrare  
 4 clip  
 4 bandierine

2 giallo



205702

€ 74,60 kit



1

h 160 - ø 30

pvc

## KIT CORNER FISSO

Kit composto da:  
 4 pali ø 30 fissi  
 4 boccole da interrare  
 4 clip  
 4 bandierine

01 Bianco

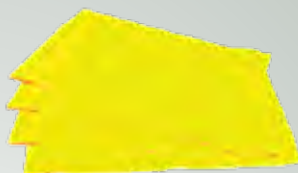

30001K

€ 63,14 kit



1

h 160 - ø 30

pvc

## KIT CORNER ECO SNODATO

Kit composto da:  
 4 pali ø 30 con snodo a molla  
 4 boccole da interrare  
 4 clip  
 4 bandierine

01 Bianco



30041K

€ 104,69 kit



1

h 160 - ø 30

pvc



## BORRACCIA

Capienza 1 litro  
Tappo a ciucio

18 Bianco/Royal

122001

€ 2,93 cad



1

lt 1

pe



## CESTELLO PORTABORRACCE

Materiale molto resistente  
6 posti

08 Royal

000072

€ 7,73 cad



1

cm 29x21x27 h

pp



## BOTTIGLIA ALLUMINIO 500 ML

Con moschettone

08 Royal  
04 Rosso

124260

€ 4,14 cad



1

500 ml

alluminio



**new**

## BORRACCIA 750 ML

Tappo a ciliegia

27 Giallo/Nero

205902

€ 2,93 cad



1

750 ml

pe



**new**

## DISPENSER MEGA MJ500

150500

€ 25,40 cad



1

lt 5



## CESTELLO PORTABORRACCE

Materiale molto resistente  
6 posti

07 Nero

2072NE

€ 7,73 cad



1

cm 29x21x27 h

pp



**new**

## BORRACCIA COLORATA

Tappo a ciucio

122008

€ 3,16 cad

100



lt 1

pe

**ORDINARE A MULTIPLI  
DI 100 PZ**

**CONSEGNA 20 GIORNI**



**BORRACCIA 1 COLORE - 400 PZ**

Con stampa personalizzata a 1 colore

CONSEGNA 45 GIORNI



122006

€ 3,26 cad

da 400 pz

lt 1

pe

**BORRACCIA 2 COLORI - 400 PZ**

Con stampa personalizzata a 2 colori

CONSEGNA 45 GIORNI



122007

€ 3,71 cad

da 400 pz

lt 1

pe

**BORRACCIA 1 COLORE - 1'200 PZ**

Con stampa personalizzata a 1 colore

CONSEGNA 45 GIORNI



122004

€ 3,01 cad

da 1200 pz

lt 1

pe

**BORRACCIA 2 COLORI - 1'200 PZ**

Con stampa personalizzata a 2 colori

CONSEGNA 45 GIORNI



122005

€ 3,42 cad

da 1200 pz

lt 1

pe

**IMPIANTO STAMPA BORRACCIA**

Prezzo per ogni singolo colore



122003

€ 199,50 cad

da 1 pz

lt 1

pe

**1.** Scegli il colore della tua borraccia



**2.** Scegli il colore del tappo



**3.** Borraccia personalizzata



COMBINAZIONE COLORI BORRACCE E TAPPI  
A VOSTRA SCELTA

PER BORRACCE PERSONALIZZATE  
MINIMO 400 PEZZI

CONSEGNA 45 GIORNI LAVORATIVI

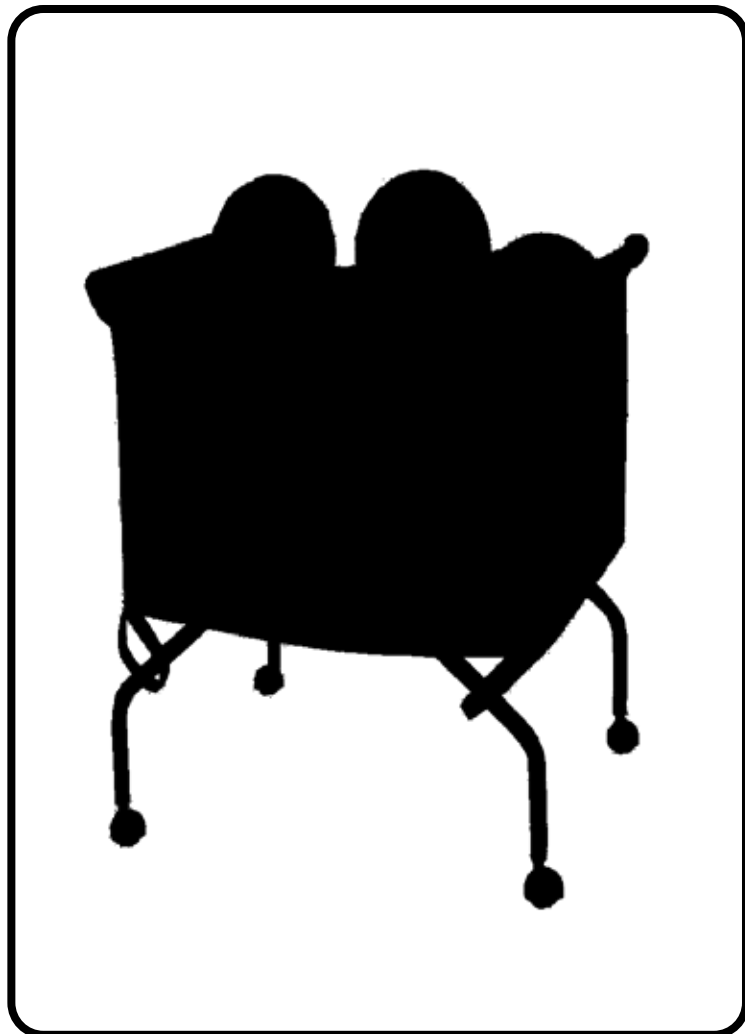

**CONTENITORE CHIUSO GRANDE**

Completo di lucchetto  
 Contiene 34/36 palloni  
 Ideale anche per la raccolta  
 accessori allenamento (ostacoli, cerchi, coni)

Altezza totale ruote comprese cm 90

00403G  
 € 366,27 cad  
 1  
 cm 100x75x78 h  
 ferro verniciato



**CONTENITORE CHIUSO MEDIO**

Completo di lucchetto  
 Contiene 24/26 palloni

Altezza totale ruote comprese cm 90

000405  
 € 304,70 cad  
 1  
 cm 75x70x78 h  
 ferro verniciato



**CONTENITORE PORTA ATTREZZI**

Ripiani regolabili in altezza  
 Ruote girevoli di cui 2 con freno  
 Completo di lucchetto



200406  
 € 1.218,00 cad  
 1  
 cm 156x76x163 h  
 acciaio zincato



**CONTENITORE CHIUSO PIEGHEVOLE**

Contiene 16/18 palloni  
 Consigliato per le piscine

Altezza totale ruote comprese cm 70

119002  
 € 156,80 cad  
 1  
 cm 80x50x55 h  
 ferro zincato



**ARMADIO PORTA ATTREZZI**

Armadio porta attrezzi metallico  
 2 porte a battente con serratura  
 4 ripiani interni regolabili



109100  
 € 451,20 cad  
 1  
 cm 180x80x40



**CONTENITORE CHIUSO ZINCATO**

Contiene 35/40 palloni  
 Consigliato per le piscine  
 In acciaio zincato tropicalizzato  
 Completo di lucchetto



21403Z  
 € 412,06 cad  
 1  
 cm 100x75x90 h  
 acciaio zincato



### CONTENITORE APERTO ZINCATO

Sacca in nylon pesante  
Pieghevole  
Sfoderabile



000402

€ 165,34 cad

1

cm 60x60x90 h

ferro zincato

### BORSA PORTAPALLONI

Contiene 12 palloni  
Con tracolla



OUTLET  
fino al esaurimento scorte

009999

€ 22,72 cad

1

pl 600

### CONTENITORE APERTO FERRO

Sacca in nylon pesante  
Pieghevole  
Sfoderabile



000401

€ 148,70 cad

1

cm 80x55x60 h

ferro

### RETE PORTAPALLONI 18

Contiene 18/20 palloni



OUTLET  
fino al esaurimento scorte

00PP18

€ 7,04 cad

1

pp

### RETE PORTAPALLONI 8

Contiene 8 palloni



new

411800

€ 4,25 cad

1

pe

### RETE PORTAPALLONI 6

Contiene 6/8 palloni



OUTLET  
fino al esaurimento scorte

000PP6

€ 5,76 cad

1

pp

### RETE PORTAPALLONI 20

Contiene 20 palloni

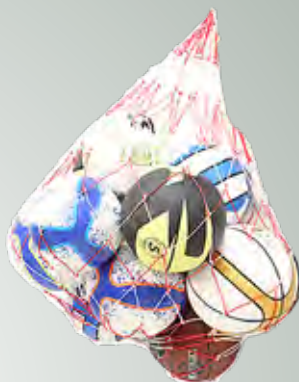

new

411700

€ 7,56 cad

1

pe

### RETE PORTAPALLONI 12

Contiene 12/14 palloni

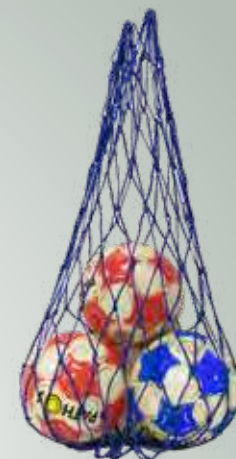

new

202700

€ 5,52 cad

1

pp

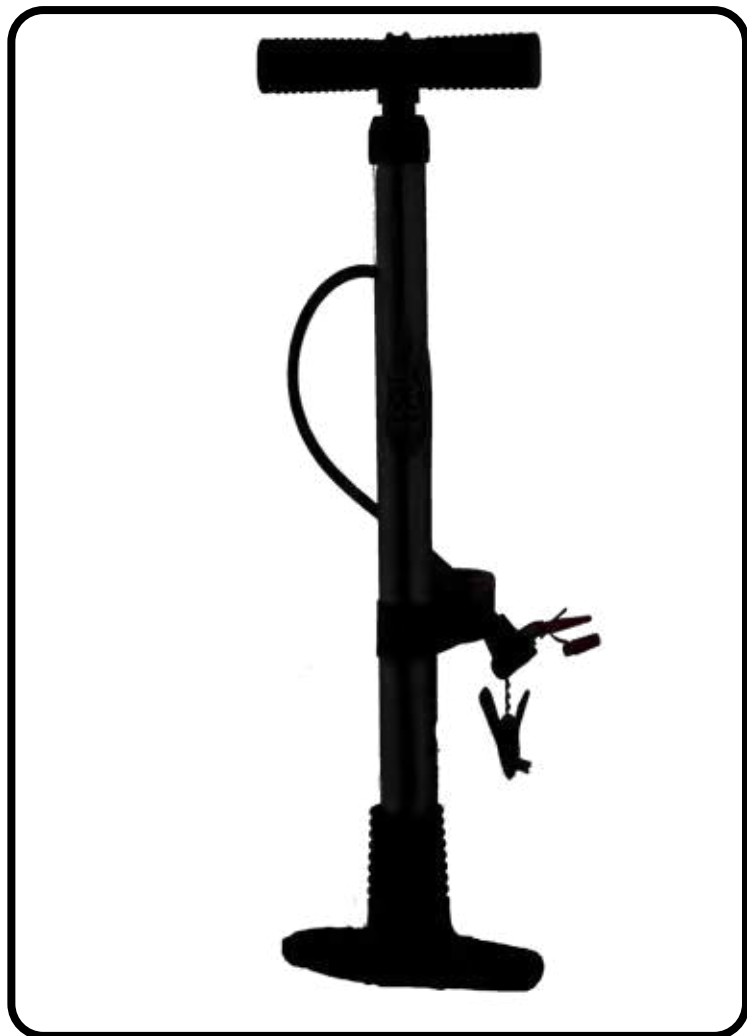

POMPA A STAFFA PRO CON MANOMETRO

Pompa con manometro a canna  
Connettori multipli non solo per palloni ma  
anche per giocattoli, biciclette, ecc  
Manometro per l'accuratezza dell'aria

TA1290
€ 27,00 cad
1
h 60
acciaio inossidabile



POMPA A MANO PRO



009002
€ 9,44 cad
1

AGO

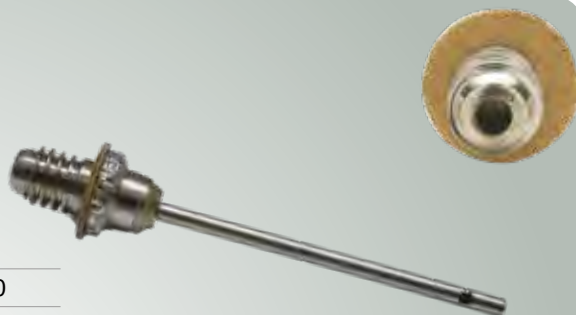

190400
€ 0,80 cad
1
metallo

POMPA A MANO QUICKER



190500
€ 6,00 cad
1
plastica

AGO PER COMPRESSORE 3 PZ

Confezione da 3 pezzi



172400
€ 5,20 conf
1
metallo

AGO PER MANOMETRO CONF. 5 PZ

Confezione da 5 pezzi



new

203103
€ 2,88 blister
1
metallo

## MINICOMPRESSORE RAIDER

2 cilindri - 220 volt  
Con maniglia per trasporto

**new**



411600

€ 188,80 cad

1

## MINICOMPRESSORE BASIC

220 volt  
Con maniglia per trasporto

**new**



410600

€ 150,24 cad

1

## MINICOMPRESSORE

2 cilindri - 220 volt  
Con maniglia per trasporto

**OUTLET**  
solo per esaurimento scorte



013001

€ 180,02 cad

1

## MANOMETRO PRO



009993

€ 12,48 cad

1

## MANOMETRO



190600

€ 9,54 cad

1



**CARRELLO SEGNACAMPO CALCE**

Con spazzola



004600

€ 375,74 cad

1

acciaio verniciato

**CARRELLO SEGNACAMPO MANUALE**

Con pompa a pressione manuale

Capacità serbatoio 10 litri

Tracciante laterale regolabile



000204

€ 443,74 cad

1

ferro verniciato

**PLIFIX SEGNACAMPO**

Utile per la segnalazione di aree di gioco e oggetti interrati

Box da 25 pezzi + applicatore



**OUTLET**  
fino al esaurimento scorte

04603B

€ 207,00 kit

1

erba sintetica

**RICAMBIO SPAZZOLA CARRELLO**

Per carrello segnacampo a calce



04600S

€ 41,60 cad

1

**IDROPITTURA**

Si vende esclusivamente a pallet da 22 taniche



1 tanica da diluire con acqua in 2 taniche

150002

€ 32,20 cad

22

lt 14

## CARRELLO SEGNACAMPO A PRESSIONE

Carrello segnacampo a spruzzo, a caricamento automatico di pressione, per pitture liquide atossiche da diluire con acqua, per manti erbosi.

La tracciatura avviene mediante la sola spinta del carrello, un meccanismo permette all'aria di essere introdotta nel flacone a pressione contenente la pittura e con pochi metri di spinta il carrello è pronto all'utilizzo. Azionando la leva posta sul manubrio avviene la fuoriuscita della pittura in maniera costante e regolare.

Tracciatura laterale regolabile.

In dotazione due diversi getti spruzzo con differenti quantità di erogazione pittura

Macchina professionale



170209

€ 1.032,47 cad



1

ferro verniciato



## MAGLIA ARBITRO

Manica corta  
2 tasche con chiusura a velcro

20 Giallo fluo

OUTLET  
in un  
assortimento scorte



A17220

€ 24,00 cad



1

da S a 2XL

pl



## BLOCCO NUMERI CAMBIO GIOCATORI

Senza manico  
Può stare nella borsa del dirigente  
Numeri da 1 a 30



031051

€ 24,26 cad



1

cm 34x24

## PANTA ARBITRO

2 tasche laterali  
con profilo giallo  
Un taschino dietro  
con chiusura velcro

07 Nero

OUTLET  
in un  
assortimento scorte



A17307

€ 12,00 cad



1

da S a 2XL

pl

## BLOCCO NUMERI CAMBIO GIOCATORI

Con manico  
Numeri da 1 a 30



031001

€ 30,75 cad



1

cm 54x24

## TABELLA CON MANIGLIE CAMBIO GIOCATORI

Bifacciale  
Numeri da 1 a 99  
Un lato con numeri gialli  
un lato con numeri arancio



FA0120

€ 48,00 cad

1

cm 58x30

pvc

## CRONOMETRO MT35

Visualizza data, ora e secondi  
Resistente all'acqua  
Batteria e cordino inclusi



15MT35

€ 15,68 cad

1

## CRONOMETRO MT38

Cronometro 30 memorie  
Segnale acustico per il Lap più veloce  
Dati cronometrici suddivisi in file  
Data, Lap, tempo totale,  
tempo più veloce e tempo medio  
Conto alla rovescia  
Resistente all'acqua  
Batteria e cordino inclusi



15MT38

€ 19,84 cad

1

## TABELLA HANDY CAMBIO GIOCATORI

Bifacciale  
Numeri da 1 a 99  
Un lato con numeri gialli  
un lato con numeri arancio

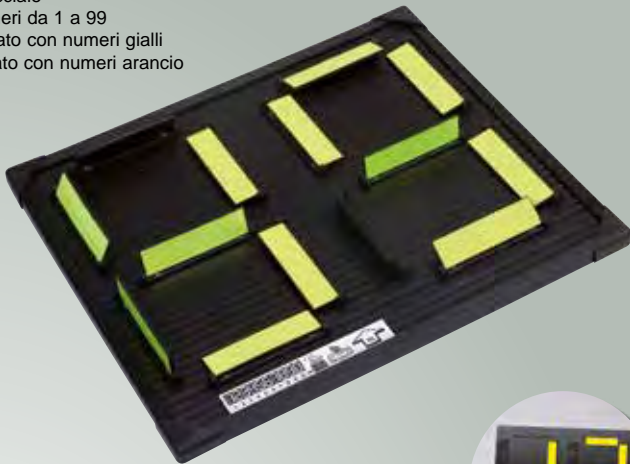

031041

€ 62,18 cad

1

cm 41x34

pvc

## CRONOMETRO MT68

Cronometro 500 memorie  
Memoria dati della sessione corrente  
Lap, tempo totale, tempo più veloce,  
tempo più lento e tempo medio  
Conto alla rovescia  
Ampio display a 3 linee  
Rivestimento gommato  
Resistente all'acqua  
Batteria e cordino inclusi



15MT68

€ 41,28 cad

1

## TABELLA CAMBIO GIOCATORI IN OUT

Tabellone elettronico a led cambio giocatori per  
calcio e rugby  
Visualizzazione su 1 lato  
Altezza cifre 23,5 cm  
Distanza leggibilità 100 m  
Resistente all'acqua  
Memorizza fino a 6 giocatori  
Batteria ricaricabile al litio



29201S

€ 627,20 cad

1

cm 58x32x2

polycarbonato

new

## FISCHIO FOX 40 CLASSIC

Fischio professionale senza pallina

- 20 Giallo fluo
- 07 Nero
- 30 Arancio fluo
- 08 Royal
- 04 Rosso
- 02 Giallo
- 06 Verde



250004

€ 7,60 cad

1

pvc

## CORDONCINO FISCHIO



401200

€ 0,85 cad

1

ny

## FISCHIO FOX 40 CMG

Fischio professionale con punta anatomica in gomma Senza pallina

- 07 Nero



250005

€ 9,28 cad

1

pvc

## CORDONCINO FISCHIO ANTIPANICO

Dotato dell'innovativo meccanismo antipanico Si sgancia da solo se rimane impigliato



250003

€ 3,23 cad

12

## FISCHIO STRIDER KIT 12 PEZZI

Ogni kit contiene 12 fischietti colore unico

- 07 Nero
- 04 Rosso



205600

€ 14,40 kit

1

pvc

## FISCHIO SYBIL

Per attività sportiva, outdoor e sicurezza personale 2 tonalità + segnale SOS Igienico Ergonomico Batterie e cordino inclusi Durata batteria da 3 a 5 mesi



190700

€ 18,56 cad

1

## FISCHIO METALLO CROMATO

Cordoncino incluso



000371

€ 3,60 cad

1

metallo



## MEGAFONO CAROL A TRANSISTOR

Alimentazione a pile



212990

€ 135,80 cad

1

## KIT GUARDALINEE

Kit composto da:  
2 aste con manopola  
2 bandierine a scacchi  
1 busta  
2 clip



140010

€ 19,75 kit

1

## BANDIERINA GIALLA GUARDALINEE



030851

€ 4,32 cad

1

cm 40x40

pl

## BANDIERINA SCACCHI GUARDALINEE



030801

€ 5,69 cad

1

cm 40x40

pl

## KIT ARBITRO FOX40

Kit professionale composto da:  
Cronometro/orologio da polso  
Fischietto Sonic Blast CMG  
Cordoncino antipanico

Orologio resistente all'acqua e agli urti



150006

€ 57,60 kit

1

## CLIP FERMABANDIERINA GUARDALINEE



030202

€ 0,54 cad

1

ø 20 mm

pe

## CUSTODIA + CARTELLINI FOOTBALL REFEREE

**new**



310050

€ 4,68 cad

1

## CARTONCINO PARTITA ARBITRO CALCIO



250002

€ 0,54 cad

10

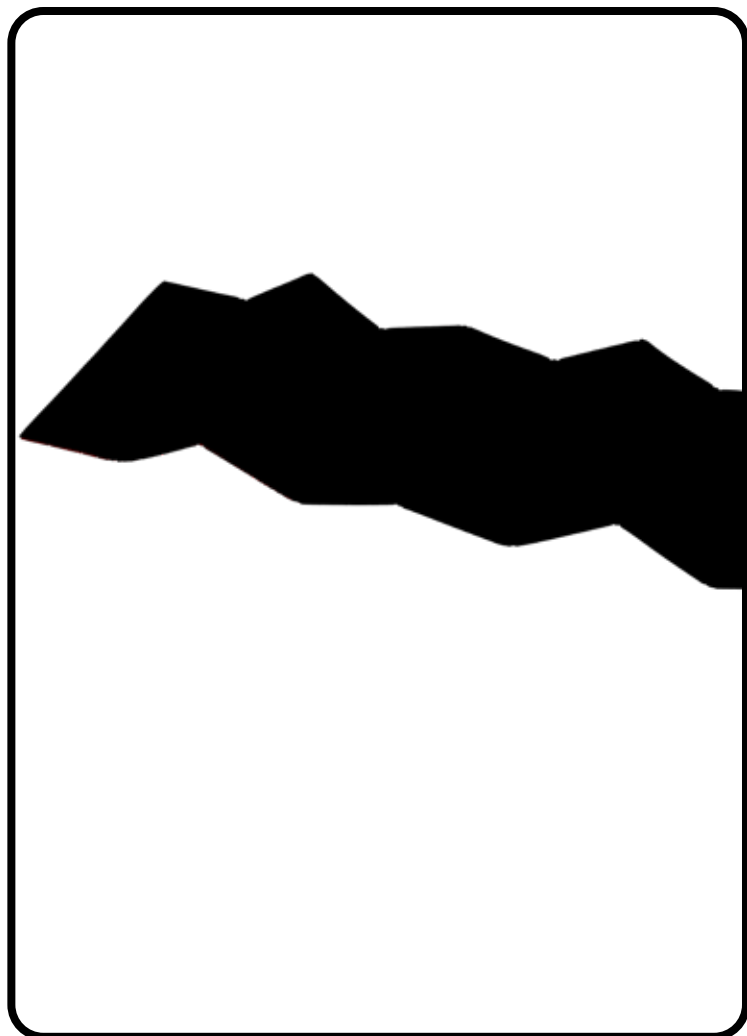

MATERASSINO PIEGHEVOLE LUNGO

Tappetino 8 pieghe  
Goffrato su 2 lati

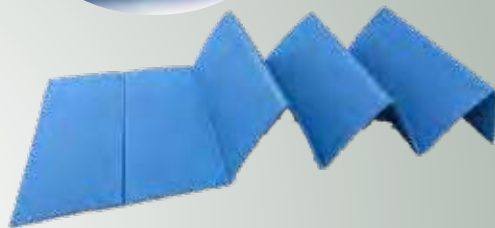
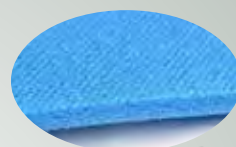

213700

€ 8,93 cad

1

cm 180x50x0,7 h

pe2

MATERASSINO PIEGHEVOLE

Reticolato



106007

€ 9,95 cad

1

cm 150x60x0,8 h

pe

MATERASSINO VINILE 3 PIEGHE

Tappetino 3 pieghe  
Goffrato su 2 lati



150901

€ 82,14 cad

1

cm 180x60x1 h

espanso riv vinile

MATERASSINO COLOR

Reticolato  
8 pieghe  
Antiscivolo  
Con 2 elastici

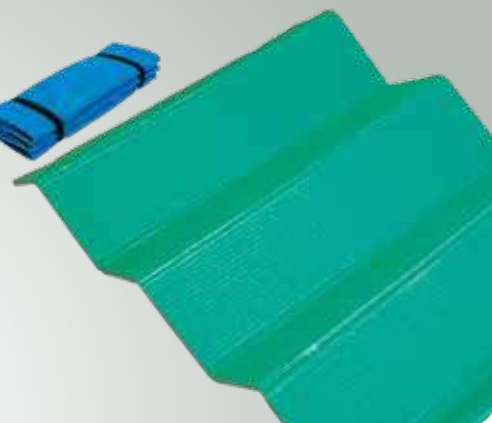
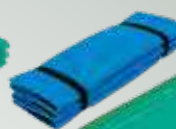

150008

€ 16,03 cad

1

cm 150x70x1 h

pe

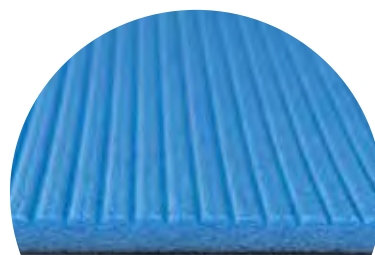

PARTICOLARE MATERASSINO COLOR

## MATERASSO H5

Per allenamento portieri



200100

€ 198,00 cad

 1

cm 200x100x5 h

gommapiuma / pvc

## FODERE

Per fodere antiscivolo prezzo a preventivo  
Antibatterico, antimuffa, ignifugo cl.2

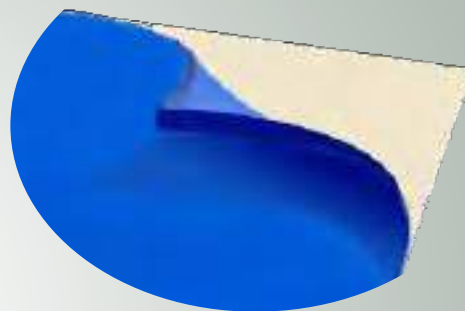

203300

€ 112,50 cad

 1

cm 200x100x5 h

pvc

## MATERASSO H10

Per allenamento portieri

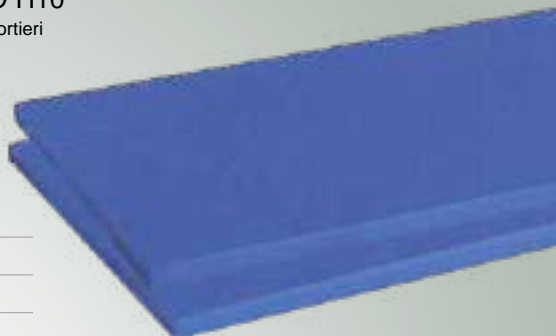

200200

€ 234,30 cad

 1

cm 200x100x10 h

gommapiuma / pvc

## FODERE

Per fodere antiscivolo prezzo a preventivo  
Antibatterico, antimuffa, ignifugo cl.2

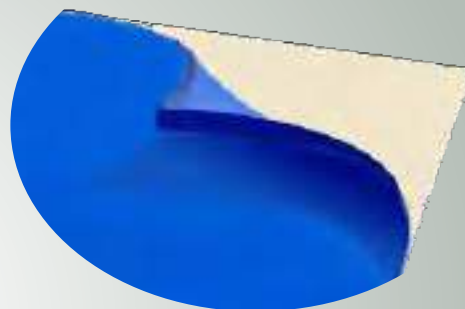

203400

€ 123,00 cad

 1

cm 200x100x10 h

pvc

## MATERASSINO YOGA

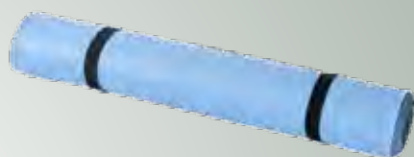

160009

€ 31,65 cad

 1

cm 170x60x0,3 h

pvc espanso



**PEDANA BAMUSTA COXIM**

Kg 0,65  
Portata massima 150 kg



009091

€ 28,62 cad

1

Ø 36

pvc free

**MEDUSA T1**

Pedana instabile che permette diversi esercizi come la percezione della staticità e lo sviluppo dell'equilibrio. Provvista di valvola per regolare il gonfiaggio a seconda del peso. Utilizzabile in entrambi i versi. Utilizzabile anche con scarpe con tacchetti. Kg 3,40

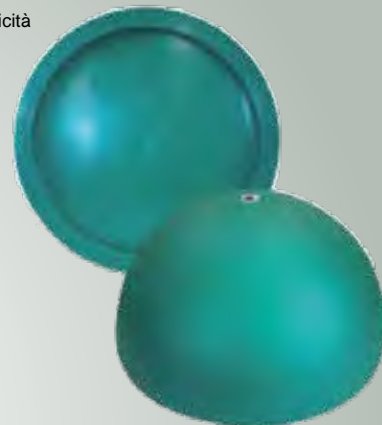

100147

€ 161,60 cad

1

Ø 45x23 h

gomma doppio strato

**PEDANA BAMUSTA COXIM XXL**

Kg 1,20  
Portata massima 150 kg



009094

€ 64,66 cad

1

Ø 50x15 h

pvc free

**MEDUSA T1.1**

Pedana ad instabilità controllata grazie all'insero rigido. Strumento ideale per stimolare la percezione sensoriale della staticità. Si gonfia come un semplice pallone. A seconda della pressione, può essere usata sia da un lato che dall'altro. Colori assortiti.

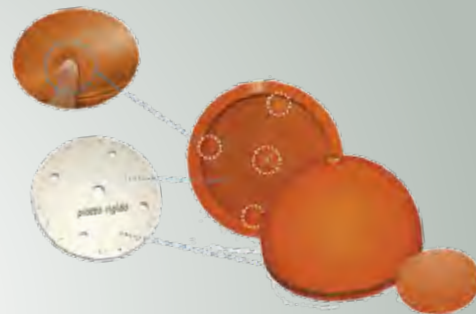

100148

€ 197,76 cad

1

Ø 45x23 h

gomma vulcanizzata

**PEDANA C1 SKIMMY**

Pedana cilindrica rigonfiabile per riabilitazione e stimolazione propriocettiva. Kg 1,20



100143

€ 121,92 cad

1

Ø 33x6 h

gomma

**PEDANA T3 PIATTO SPECIALE**

La parte inferiore che appoggia al terreno è stata progettata per dare il massimo del grip anche sui campi sintetici. Kg 4,90

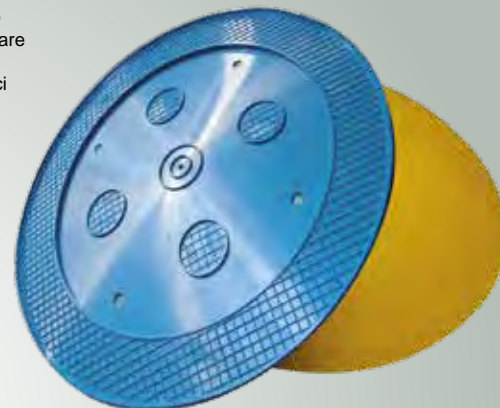

100146

€ 259,84 cad

1

Ø 55x15 h

gomma

**PEDANA C2 SUPER SKIMMY**

Pedana cilindrica rigonfiabile per riabilitazione e stimolazione propriocettiva. Kg 2,20



100144

€ 158,40 cad

1

Ø 40x90 h

gomma

**TARTARUGA T2**

Attrezzo adatto al riscaldamento, potenziamento, riabilitazione e stimolazione propriocettiva di atleti ma anche di anziani e bambini. Colori assortiti.



100149

€ 285,60 cad

1

Ø 65x24 h

## SEMISFERA STIMOLAZIONE MH16

Realizzata in gomma sintetica super soffice  
Particolare superficie a rilievi  
Confezione colori assortiti



100151

€ 26,88 cad

6

ø 16x9 h

gomma

## TAVOLETTA PROPRIOCEATTIVA DOIS

Su emisfera regolabile in 2 altezze  
da cm 5,50 a cm 9  
Ideale per l'allenamento sportivo e la riabilitazione



009092

€ 30,46 cad

1

ø 42

abs

## SEMISFERA BALANCE IGEL

Realizzata in gomma sintetica super soffice  
Particolare superficie a rilievi



210900

€ 10,53 cad

1

ø 16X7 h

gomma

## TAVOLETTA PROPRIOCEATTIVA

Tavoletta per esercizi di equilibrio  
Ideale per l'allenamento sportivo e la riabilitazione



TA0540

€ 23,40 cad

1

ø 41

abs

## PEDANA MEIA

Strumento di allenamento versatile  
Per esercizi di equilibrio e per rafforzare i muscoli  
La pedana Meia è un mix tra palla Bureba e Pedana Proprioceattiva  
Superficie antiscivolo  
Portata massima peso 200 kg

Pompa inclusa



96000A

€ 169,83 cad

1

ø 60x22 h

gomma doppio strato

## TAVOLETTA PROPRIOCEATTIVA LEGNO

Su emisfera base di appoggio  
Antiscivolo  
Ideale per l'allenamento sportivo e la riabilitazione



144930

€ 44,64 cad

1

ø 40

legno

## PEDANA C3 SUPERSKIMMY PROFESSIONAL

Pedana per l'allenamento e per la riabilitazione della caviglia e del ginocchio  
Ideale per la rieducazione dei disturbi di equilibrio e per l'allenamento presciistico  
Può essere utilizzata con o senza scarpe ed è resistente ai tacchetti  
Colori assortiti



100145

€ 181,44 cad

1

ø 40x9 h

gomma reticolata

## TAVOLETTA PROPRIOCEATTIVA SEMILUNE



150070

€ 78,00 cad

1

cm 60x40

legno



**CORDA SALTO CANAPONE**

Ingrossamento centrale

180900
€ 4,95 cad
 10
mt 3



**CORDA SALTO CANAPONE - CON MANICO**

Ingrossamento centrale  
Manici in legno

050001
€ 6,27 cad
 1
mt 3



**CORDA SALTO**

Manici in legno  
Lunghezza regolabile

974200
€ 3,42 cad
 1
mt 2,80



**KIT CORDE SALTO VELOCE PRO**

Kit composto da 3 corde in acciaio di spessore diverso



200510
€ 32,80 kit
 1
acciaio



### IMBRAGATURA DOPPIA PER RESISTENZA

Imbragatura doppia ideale per esercizi di resistenza in coppia  
Entrambe le cinture sono cucite con un elastico che raggiunge la lunghezza massima di 6 mt



TA0460

€ 32,40 cad

1



### ELASTICO RINFORZA ABDUTTORI

Elastico che permette di lavorare sugli adduttori ed abduttori  
Corda flessibile per gli esercizi di equilibrio

TA0470

€ 25,60 cad

1



### POWER SPEED RESISTOR

Incrementa forza nella gamba  
Esercizio in coppia



106006

€ 34,80 cad

1

nylon non elastico



### BANDA RINFORZA ABDUTTORI

Con velcro cucito su entrambe le estremità



180300

€ 36,48 cad

1

RINFORZA ABDUTTORI



### CORDA ELASTICA PER RESISTENZA



200490

€ 83,99 cad

1

mt 2,40



### ELASTICO INTENSITA' VARIABILE

Con velcro cucito su entrambe le estremità



181410

€ 10,76 cad

1

cm 20x4x2

pl



## SLITTA DA TRAINO COMPLETA

Pesi esclusi



032055

€ 146,18 cad

1

ferro verniciato

## RUOTA DOPPIA PER ADDOMINALI

Ideale per lavorare su addominali, braccia, spalle e avambracci



200670

€ 13,79 cad

1

## SACCA DI TRAINO SPRINTSAC

Sacche riempibili con sabbia fino a 20 kg



100800

€ 146,41 cad

1

## MANUBRI CON RUOTE PER ADDOMINALI



209000

€ 30,82 coppia

1

## PALLONE CALCIO POTENZIATO

Utilizzati per aumentare il reclutamento delle fibre muscolari  
Non tossico - senza lattice  
Peso gr 630  
Ø 21,5



100074

€ 47,32 cad

1

gomma doppio strato



## PARACADUTE

Per potenziamento della corsa esercizio individuale

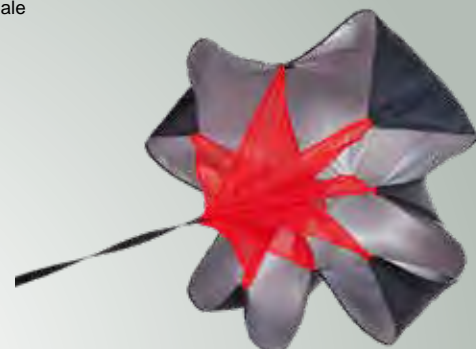

200470

€ 32,62 cad

1

pl

## LACCI DI TRAZIONE DINAMICI CON CARRUCOLA



182300

€ 183,60 cad

1

## BANDA RESISTENZA LIGHT

new

200090

€ 10,66 cad

1

cm 102x1,3



## ATTREZZO SUSPENTION TRAINER PRO

new



201830

€ 61,34 cad

1

## BANDA RESISTENZA MEDIUM

new

200010

€ 12,61 cad

1

cm 102x1,3



## BANDA RESISTENZA HEAVY

new

200110

€ 20,10 cad

1

cm 102x2,8



## BANDA RESISTENZA EXTRA HEAVY

new

200120

€ 30,59 cad

1

cm 102x4,4

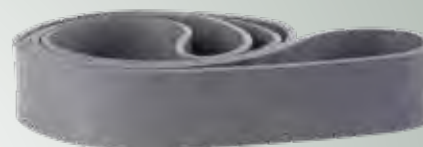



BORSA ZAVORRATA POWER BAG KG 5



201710
€ 101,02 cad
1
kg 5



BORSA ZAVORRATA POWER BAG KG 10



201720
€ 106,99 cad
1
kg 10



BORSA ZAVORRATA POWER BAG KG 25



202260
€ 151,60 cad
1
kg 25



BORSA ZAVORRATA POWER BAG KG 15



201730
€ 113,00 cad
1
kg 15



BORSA ZAVORRATA POWER BAG KG 20



202250
€ 143,60 cad
1
kg 20



## CAVIGLIERA 0,5 KG

Singolo pezzo

**OUTLET**  
fino al esaurimento scorte



002031

€ 5,98 cad

1

cm 36x12



## CAVIGLIERA 2 KG

Singolo pezzo

**OUTLET**  
fino al esaurimento scorte



002034

€ 13,00 cad

1

cm 41x15,5



## CAVIGLIERA 1 KG

Singolo pezzo

**OUTLET**  
fino al esaurimento scorte



002032

€ 8,71 cad

1

cm 36x13

## CAVIGLIERA 2,5 KG

Singolo pezzo

**OUTLET**  
fino al esaurimento scorte



002035

€ 15,16 cad

1

cm 47x16,5

## CAVIGLIERA CUFFS KG 1

Singolo pezzo

**new**



002042

€ 11,90 cad

1

cm 36x13

## CAVIGLIERA CUFFS KG 1,5

Singolo pezzo

**new**



002043

€ 14,62 cad

1

cm 36x13

## CAVIGLIERA CUFFS KG 2

Singolo pezzo

**new**



002044

€ 16,15 cad

1

cm 36x13

## CAVIGLIERA CUFFS KG 3

Singolo pezzo

**new**



002046

€ 24,82 cad

1

cm 36x13

**PALLA MEDICA NEW NEMO 1 KG**

Con valvola rigonfiabile  
Ideale per allenamento  
e potenziamento in tutte  
le discipline sportive  
Approvato IAAF

Ø 19 cm

100113

€ 22,72 cad

1

kg 1

gomma sintetica

**PALLA MEDICA NEW NEMO 4 KG**

Con valvola rigonfiabile  
Ideale per allenamento  
e potenziamento in tutte  
le discipline sportive

Ø 24 cm

100116

€ 59,20 cad

1

kg 4

gomma sintetica

**PALLA MEDICA NEW NEMO 2 KG**

Con valvola rigonfiabile  
Ideale per allenamento  
e potenziamento in tutte  
le discipline sportive

Ø 19 cm

100114

€ 39,04 cad

1

kg 2

gomma sintetica

**PALLA MEDICA NEW NEMO 5 KG**

Con valvola rigonfiabile  
Ideale per allenamento  
e potenziamento in tutte  
le discipline sportive

Ø 24 cm

100117

€ 74,56 cad

1

kg 5

gomma sintetica

**PALLA MEDICA NEW NEMO 3 KG**

Con valvola rigonfiabile  
Ideale per allenamento  
e potenziamento in tutte  
le discipline sportive

Ø 19 cm

100115

€ 50,24 cad

1

kg 3

gomma sintetica

**PALLA MEDICA NEW NEMO 6 KG**

Con valvola rigonfiabile  
Ideale per allenamento  
e potenziamento in tutte  
le discipline sportive

Ø 24 cm

100118

€ 88,32 cad

1

kg 6

gomma sintetica

**PALLA MEDICA MORBIDA 100 GR**

Palla medica particolare riempita con acqua distillata  
Silenziosa al rimbalzo e gradevole al tatto  
Utilizzata per la riabilitazione e per esercizi di palleggio nel volley  
Ø 12

180801

€ 25,28 cad

1

gr 100

gomma

**PALLA MEDICA MORBIDA 300 GR**

Palla medica particolare riempita con acqua distillata  
Silenziosa al rimbalzo e gradevole al tatto  
Utilizzata per la riabilitazione e per esercizi di palleggio nel volley  
Ø 18

180803

€ 36,48 cad

1

gr 300

gomma



## PALLA MEDICA SPIK 5 KG

OUTLET  
fino al esaurimento scorte



170105
€ 45,73 cad
1
kg 5
gomma

## PALLA MEDICA SPIK 1 KG

OUTLET  
fino al esaurimento scorte



170101
€ 20,93 cad
1
kg 1
gomma

## PALLA MEDICA OVER CON IMPUGNATURA 0.5 KG

Palla vibrata in gomma reticolata ad alto peso specifico  
Adatta per la simulazione tecnica del lancio, per esercizi di potenziamento, riabilitazione, aerobica ed esercizi in acqua  
Impugnatura soffice e rebusta  
Galleggia



180605
€ 29,44 cad
1
kg 0,5
gomma reticolata

## PALLA MEDICA SPIK 2 KG

OUTLET  
fino al esaurimento scorte



170102
€ 26,50 cad
1
kg 2
gomma

## PALLA MEDICA OVER CON IMPUGNATURA 1 KG

Palla vibrata in gomma reticolata ad alto peso specifico  
Adatta per la simulazione tecnica del lancio, per esercizi di potenziamento, riabilitazione, aerobica ed esercizi in acqua  
Impugnatura soffice e rebusta  
Galleggia



180610
€ 32,64 cad
1
kg 1
gomma reticolata

## PALLA MEDICA SPIK 3 KG

OUTLET  
fino al esaurimento scorte



170103
€ 32,03 cad
1
kg 3
gomma

## PALLA MEDICA OVER CON IMPUGNATURA 1.5 KG

Palla vibrata in gomma reticolata ad alto peso specifico  
Adatta per la simulazione tecnica del lancio, per esercizi di potenziamento, riabilitazione, aerobica ed esercizi in acqua  
Impugnatura soffice e rebusta  
Galleggia



180615
€ 36,16 cad
1
kg 1,5
gomma reticolata

## PALLA MEDICA SPIK 4 KG

OUTLET  
fino al esaurimento scorte



170104
€ 39,81 cad
1
kg 4
gomma

**MANUBRIO VINYL 0,5 KG**Ghisa ricoperta in vinile  
Singolo pezzo

002021

€ 2,74 cad

1

kg 0,5

ghisa / vinile

**MANUBRIO VINYL 3 KG**Ghisa ricoperta in vinile  
Singolo pezzo

002025

€ 15,16 cad

1

kg 3

ghisa / vinile

**MANUBRIO VINYL 1 KG**Ghisa ricoperta in vinile  
Singolo pezzo

002022

€ 5,04 cad

1

kg 1

ghisa / vinile

**MANUBRIO VINYL 4 KG**Ghisa ricoperta in vinile  
Singolo pezzo

002026

€ 20,20 cad

1

kg 4

ghisa / vinile

**MANUBRIO VINYL 1,5 KG**Ghisa ricoperta in vinile  
Singolo pezzo

002023

€ 7,67 cad

1

kg 1,5

ghisa / vinile

**MANUBRIO VINYL 5 KG**Ghisa ricoperta in vinile  
Singolo pezzo

002027

€ 22,97 cad

1

kg 5

ghisa / vinile

**MANUBRIO VINYL 2 KG**Ghisa ricoperta in vinile  
Singolo pezzo

002024

€ 10,12 cad

1

kg 2

ghisa / vinile

## DISCO IN GHISA 0,5 KG

Rivestimento in gomma  
Foro ø 26 mm



100014

€ 2,74 cad

1

kg 0,5

ghisa

## GUANTO PALESTRA MEN

Lavabile, traspirabile  
Sottomano antiscivolo



800080

€ 7,50 paio

1

L/XL

neoprene

## DISCO IN GHISA 1 KG

Rivestimento in gomma  
Foro ø 26 mm



100015

€ 5,45 cad

1

kg 1

ghisa

## GUANTO PALESTRA LADIES

Lavabile, traspirabile  
Sottomano antiscivolo



800700

€ 7,50 paio

1

S/M

neoprene

## FERMADISCHI A MOLLA



133111

€ 4,95 paio

1

ø 26 mm



## PALLA GINNICA 75

Palla professionale  
2 strati

100106

€ 69,12 cad



1

ø 75

gomma



## PALLA GINNICA 65

Palla professionale  
2 strati

100105

€ 64,64 cad



1

ø 65

gomma



## MATERASSINO YOGA

160009

€ 31,65 cad



1

cm 170x60x0,3 h

pvc espanso

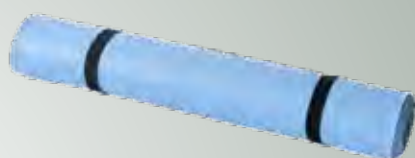

## PALLA GINNICA 55

Palla professionale  
2 strati

100104

€ 53,44 cad



1

ø 55

gomma



## PALLA GINNICA BUREBA BALL



72400A

€ 27,03 cad



1

ø 65 cm

pvc



## STEP 67x27

Step ideale per lavorare sulla coordinazione, sull'agilità, sulla resistenza e sui muscoli  
Salendo e scendendo vengono fatti lavorare moltissimi muscoli  
Con 2 diverse altezze per aumentare la difficoltà  
Facilmente trasportabile

TA1430
€ 44,00 cad
1
h 10/15
pvc antiscivolo



## STEP REGOLABILE

Piano antiscivolo  
Regolabile in 3 altezze cm 15 / 20 / 25  
Peso kg 7,5

090095
€ 159,84 cad
1
cm 90x35 h
abs

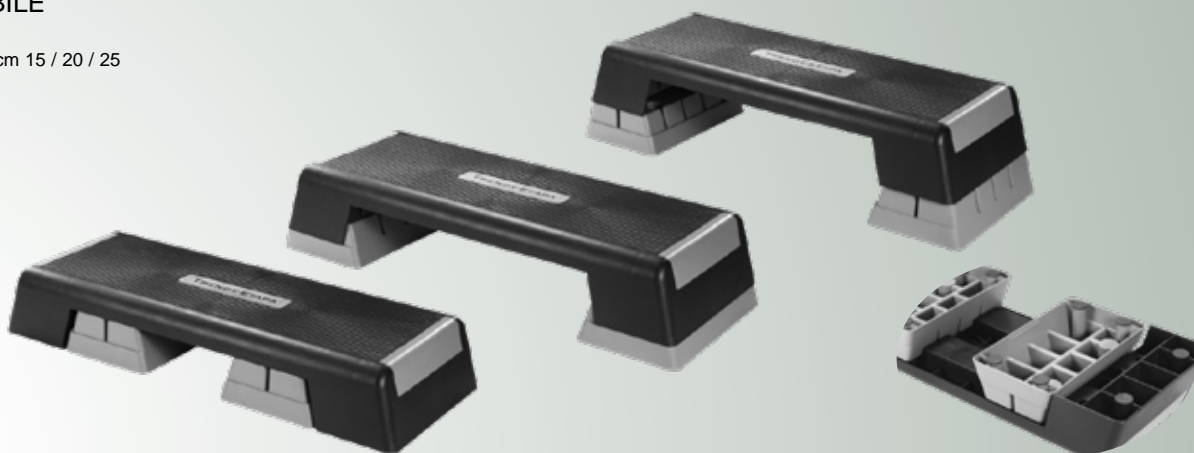

Scegli il diametro della palla per eseguire gli esercizi, misurando la lunghezza del tuo braccio

LUNGHEZZA BRACCIO	DIAMETRO PALLA
56-65 cm	55 cm
66-80 cm	65 cm
81-90 cm	75cm



**ELASTICO ROTOLO LIMITE - LIGHT**

Elastico utilizzato per la riabilitazione e per l'aerobica  
Utilizzabile per esercizi di stretching per la parte superiore del corpo e per le gambe  
Stimola la costruzione muscolare e migliora la forma fisica e l'allenamento del corpo  
Rotolo da 25 mt tagliabile

Adatto per la riabilitazione  
Spessore 0,20 mm

210300

€ 56,09 cad

1

mt 25x15 cm

lattice

**ELASTICO BANDA LIMITE - LIGHT**

Adatto per la riabilitazione  
Spessore 0,40 mm  
Trazione fino a 5,5 kg

671710

€ 7,42 cad

1

mt 2,5x15 cm

lattice

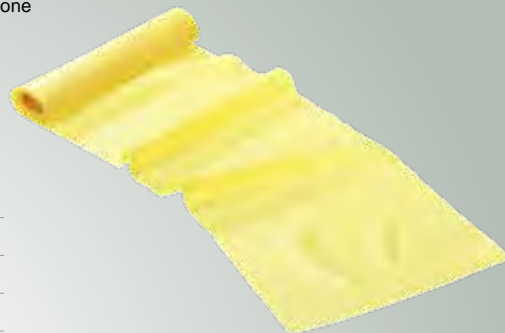
**ELASTICO ROTOLO LIMITE - MEDIUM**

Elastico utilizzato per la riabilitazione e per l'aerobica  
Utilizzabile per esercizi di stretching per la parte superiore del corpo e per le gambe  
Stimola la costruzione muscolare e migliora la forma fisica e l'allenamento del corpo  
Rotolo da 25 mt tagliabile

Adatto per la riabilitazione e aerobica  
Spessore 0,25 mm

210400

€ 66,06 cad

1

mt 25x15 cm

lattice

**ELASTICO BANDA LIMITE - MEDIUM**

Adatto per la riabilitazione  
Spessore 0,45 mm  
Trazione fino a 6,8 kg

671720

€ 7,85 cad

1

mt 2,5x15 cm

lattice

**ELASTICO ROTOLO LIMITE - STRONG**

Elastico utilizzato per la riabilitazione e per l'aerobica  
Utilizzabile per esercizi di stretching per la parte superiore del corpo e per le gambe  
Stimola la costruzione muscolare e migliora la forma fisica e l'allenamento del corpo  
Rotolo da 25 mt tagliabile

Adatto per l'aerobica avanzata  
Spessore 0,30 mm

210500

€ 75,82 cad

1

mt 25x15 cm

lattice

**ELASTICO BANDA LIMITE - HEAVY**

Adatto per la riabilitazione  
Spessore 0,50 mm  
Trazione fino a 7,8 kg

671730

€ 8,78 cad

1

mt 2,5x15 cm

lattice

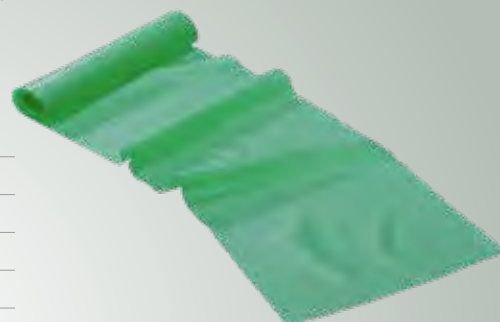
**ELASTICO ROTOLO LIMITE - STRONG EXTRA**

Elastico utilizzato per la riabilitazione e per l'aerobica  
Utilizzabile per esercizi di stretching per la parte superiore del corpo e per le gambe  
Stimola la costruzione muscolare e migliora la forma fisica e l'allenamento del corpo  
Rotolo da 25 mt tagliabile

Adatto per la muscolatura già allenata  
Spessore 0,35 mm

210600

€ 85,68 cad

1

mt 25x15 cm

lattice

**ELASTICO BANDA LIMITE - X-HEAVY**

Adatto per la riabilitazione  
Spessore 0,55 mm  
Trazione fino a 9,10 kg

671740

€ 10,12 cad

1

mt 2,5x15 cm

lattice



## ELASTICO ANELLO TONE-LOOP - MEDIUM

Spessore 0,7 mm  
Trazione fino a 11-13,5 kg



670820

€ 3,37 cad

1

cm 30x5 h

lattice

## ELASTICO TUBE MEDIUM

Elastico con maniglie adatto per la riabilitazione dei muscoli e per l'aerobica. Utilizzati per esercizi di stretching per la parte superiore del corpo e gambe. Stimola la costruzione muscolare e migliora la forma fisica e l'allenamento del corpo.

Adatto per aerobica e riabilitazione



680120

€ 9,58 cad

1

lattice

## ELASTICO ANELLO TONE-LOOP - HEAVY

Spessore 0,9 mm  
Trazione fino a 13,5-15,80 kg



670830

€ 4,05 cad

1

cm 30x5 h

lattice

## ELASTICO TUBE STRONG

Elastico con maniglie adatto per la riabilitazione dei muscoli e per l'aerobica. Utilizzati per esercizi di stretching per la parte superiore del corpo e gambe. Stimola la costruzione muscolare e migliora la forma fisica e l'allenamento del corpo.

Adatto per aerobica e riabilitazione



680130

€ 10,22 cad

1

lattice



## CERCHIO PILATES RING



905600

€ 33,83 cad

1

ø 38

pe

## PALLA SOFFICE TENDER BALL

La palla tender è estremamente soffice e leggera perchè realizzata in gomma soffiata.

Ideale per il gioco dei più piccoli ma anche per tutti gli esercizi di rafforzamento e di stimolazione tattile.

Fondamentale nelle mobilizzazioni di capo e bacino.

Tutte rigonfiabili anche con una semplice cannuccia (inclusa).



108004

€ 29,76 cad

1

gomma soffiata

## TUBO PILATES CM 70

Tubo pilates in schiuma PE

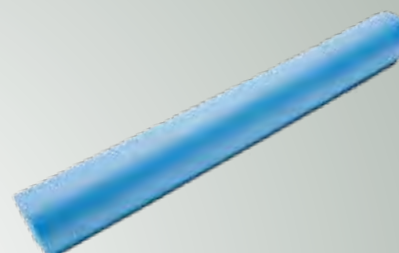

900100

€ 36,96 cad

1

cm 70x15 ø

schiuma pe



SOSPENSORIO CON CONCHIGLIA

Conchiglia estraibile

012566

€ 15,20 cad

1



S - M - L

35% pes - 29% co

17% helanca

10% viscosa - 9%elastico



COSCIERA ELASTICA SINGOLA



205300

€ 3,60 cad

1



S - M - L - XL

PARADENTI SINGOLO FOX40



V00034

€ 3,20 cad

1



mis unica

GINOCCHIERA ELASTICA



125680

€ 3,10 cad

1



M - L

FASCIA PER CAPELLI HAIRBAND

Kit composto da 3 fasce per capelli



320000

€ 7,99 kit

1



CAVIGLIERA ELASTICA

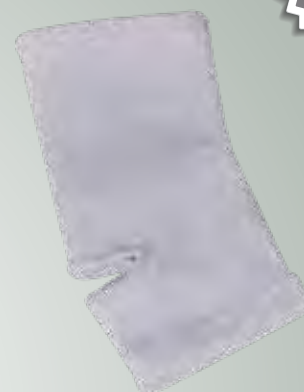

006670

€ 3,10 cad

1



M - L

## CIABATTA EVA

Misure dal 36 al 46  
Materiale EVA molto leggero e antifungino

01 Blu



800070

€ 9,50 paio

1

36-46

eva

## CINTURA NEOPRENE



125610

€ 16,96 cad

1

cm 125x24

neoprene

## POGGIAPIEDI FOOTSY

Idrorepellente

09 Blu  
70 Grigio  
60 Verde fluo  
03 Rosso  
11 Cielo



458590

€ 15,62 cad

10

cm 33x41x1,5

colori misti

## POGGIAPIEDI TAPPETINO SACCA

Trasformabile in sacca per  
indumenti umidi  
Dimensioni da chiuso cm 16x11x3 h



161240

€ 8,48 cad

1

ø 65

pl

**TALLONIERA TULI'S HEAVY DUTY SMALL  
FINO A 40 KG**

Struttura a nido d'ape che permette di assorbire gli urti che subiamo quando camminiamo o pratichiamo attività fisica

Riduce la pressione laterale contro il tendine d'Achille  
Allevia numerosi disturbi quali borsite del calcagno, apofisite, fascite

190201

€ 19,20 paio

1

- 40 kg

**SOLETTA CARBONE ATTIVO**

Sottopiede in lattice ai carboni attivi  
Spessore 3,3 mm  
Ritagliabile

160333

€ 2,48 paio

12

misura unica

lattice

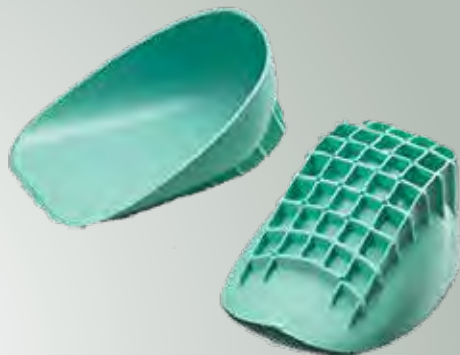
**TALLONIERA TULI'S HEAVY DUTY REGULAR  
DA 40 A 80 KG**

190202

€ 19,20 paio

1

max 80 kg

**PLANTARE ANATOMICO ANTIBATTERICO SPORT**

Plantare anatomico con supporto arcoplantare e goccia metatarsale

Misure:

35/36

37/38

39/40

41/42

43/44

45/46

000621

€ 9,20 paio

1

lattice

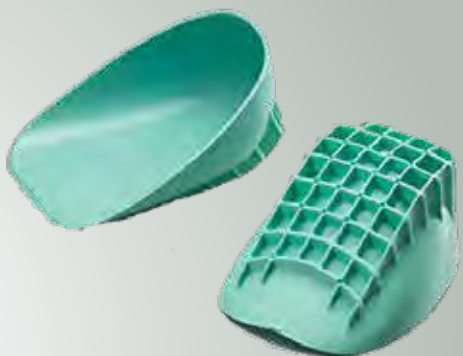
**TALLONIERA TULI'S HEAVY DUTY LARGE  
OLTRE 80 KG**

190203

€ 19,20 paio

1

oltre 80 kg

**SOTTOPIEDE ANATOMICO**

Misure:

Dal 36 al 46

452000

€ 2,48 paio

1

36 - 46

**SOLETTA SPUGNA**

Misure:  
Dal 35 al 46

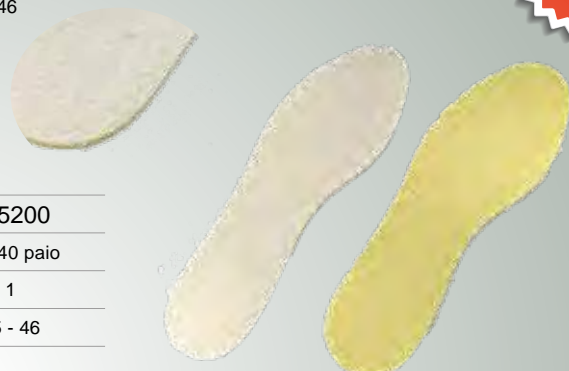
**new**

205200

€ 2,40 paio

1

35 - 46

**SOTTOPIEDE BIDENSITA' ANATOMICO**

Misure:

Dal 39 al 46

451000

€ 3,30 paio

1

39 - 46



## SOLETTA PWR-GEL COMFORT INSOLE

Misura: 36/43  
Misura: 44/49



S60031

€ 19,20 paio



1

36/43 44/49

## SOLETTA FLEXALIGN

Misura: 36/43  
Misura: 44/49



S60032

€ 19,20 paio



1

36/43 44/49

## TALLONIERA GEL HEEL CUSHIONS

Progettata per dare sollievo e protezione al tallone dagli impatti

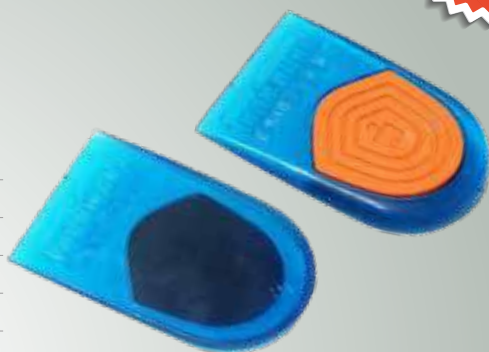

S60030

€ 15,04 paio



1

misura unica



GRASSO FOCA 50 ML



000083
€ 3,36 cad
24
50 ml

GRASSO FOCA SPRAY



000441
€ 5,82 cad
12
200 ml

GRASSO FOCA 100 ML



000084
€ 4,42 cad
24
100 ml

SPAZZOLA PER GRASSO



000522
€ 3,52 cad
1
cm 11x4,5
legno

GRASSO FOCA TUBETTO



000080
€ 3,04 cad
24
75 ml

TENDISCARPE A MOLLA

Misure:  
35/37  
38/40  
40/42  
43/45



000611
€ 4,48 paio
1

GRASSO FOCA BARATTOLO 1 KG



000088
€ 23,36 cad
1
1 kg

LACCI SCARPE CALCIO

- 02 Giallo
- 01 Bianco
- 07 Nero
- 04 Rosso
- 08 Royal



140388
€ 1,60 paio
20
cm 180

## DEPILSPRAY

Schiuma depilatoria  
Ideale per utilizzo sportivo grazie alla sua azione rapida



171000

€ 13,38 cad

1

200 ml

## SCALDAMANI HAND WARMER

Ideale per tenere al caldo le mani



780053

€ 2,21 cad

40

## STRISCE DEPILATORIE

Strisce depilatorie  
Ideali per utilizzo sportivo  
Olio di mandorle incluso per rimuovere residui di cera  
Ogni confezione include 40 strisce



191240

€ 11,40 conf

1

40 strisce

## SCALDAPIEDI TOE WARMER

Ideale per tenere al caldo i piedi



780046

€ 2,41 cad

40

## CREMA SOPRASELLA REFRESH

Crema antisfregamento per proteggere la pelle del soprasella durante il ciclismo



191325

€ 16,79 paio

1

## SOLETTA PIEDI FOOT WARMER

Ideale per tenere al caldo i piedi



780053

€ 4,86 cad

24



## TACCHETTO NYLON METALLO MM 11

Confezione da 100 pz  
mm 11

Colore rosso

000237
€ 28,00 conf
1
ny / metallo



## TACCHETTO NYLON METALLO MM 13

Confezione da 100 pz  
mm 13

Colore bianco

000238
€ 28,00 conf
1
ny / metallo



## TACCHETTO NYLON METALLO MM 11/15 TRICOLORE BLISTER

4 pz mm 11 rosso  
4 pz mm 13 bianco  
4 pz mm 15 verde



000235
€ 4,20 blister
1
ny / metallo

## TACCHETTO NYLON METALLO MM 15

Confezione da 100 pz  
mm 15

Colore verde

000239
€ 28,00 conf
1
ny / metallo



## TACCHETTO NYLON METALLO MM 13/17 TRICOLORE BLISTER

4 pz mm 13 bianco  
4 pz mm 15 verde  
4 pz mm 17 rosso



000236
€ 4,20 blister
1
ny / metallo

## TACCHETTO NYLON METALLO MM 17

Confezione da 100 pz  
mm 17

Colore rosso

000240
€ 28,00 conf
1
ny / metallo



## TACCHETTO NYLON METALLO MM 13/16 BLISTER

8 pz mm 13  
4 pz mm 16

Colore nero

220007

€ 4,76 blister

 20

ny / metallo



## TACCHETTO NYLON METALLO MM 13/16 BLISTER

8 pz mm 13  
4 pz mm 16

Scatola con blister di colori assortiti



220ASS

€ 4,76 blister

 20

ny / metallo

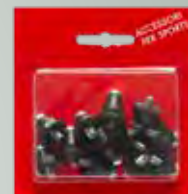

## TACCHETTO NYLON METALLO MM 13

Confezione da 100 pz  
mm 13

Colore bianco

221001

€ 29,40 conf

 1

ny / metallo



## TACCHETTO NYLON METALLO MM 16

Confezione da 100 pz  
mm 16

Colore bianco

222001

€ 29,40 conf

 1

ny / metallo



## TACCHETTO NYLON METALLO MM 13

Confezione da 100 pz  
mm 13

Colore rosso

221004

€ 29,40 conf

 1

ny / metallo



## TACCHETTO NYLON METALLO MM 16

Confezione da 100 pz  
mm 16

Colore rosso

222004

€ 29,40 conf

 1

ny / metallo



## TACCHETTO NYLON METALLO MM 13

Confezione da 100 pz  
mm 13

Colore nero

221007

€ 29,40 conf

 1

ny / metallo



## TACCHETTO NYLON METALLO MM 16

Confezione da 100 pz  
mm 16

Colore nero

222007

€ 29,40 conf

 1

ny / metallo



TACCHETTO NYLON METALLO MM 11/16  
TRASPARENTE  
BLISTER

4 pz mm 11  
4 pz mm 13  
4 pz mm 16



000230

€ 7,28 blister

20

ny / metallo

TACCHETTO NYLON METALLO MM 13/16 BICOLORE  
BLISTER

8 pz mm 13  
4 pz mm 16

Scatola con blister di colori  
assortiti



223ASS

€ 6,16 blister

20

ny / metallo

TACCHETTI NYLON METALLO MM 11 TRASPARENTE

Confezione da 100 pz  
mm 11



000231

€ 47,60 conf

1

ny / metallo

TACCHETTO NYLON METALLO MM 13 BICOLORE

Confezione da 100 pz  
mm 13

Colore bianco/nero



224000

€ 44,80 conf

1

ny / metallo

TACCHETTI NYLON METALLO MM 13 TRASPARENTE

Confezione da 100 pz  
mm 13



000232

€ 47,60 conf

1

ny / metallo

TACCHETTO NYLON METALLO MM 16 BICOLORE

Confezione da 100 pz  
mm 16

Colore bianco/nero



225000

€ 44,80 conf

1

ny / metallo

TACCHETTI NYLON METALLO MM 16 TRASPARENTE

Confezione da 100 pz  
mm 16



000233

€ 47,60 conf

1

ny / metallo

### TACCHETTO NYLON MM 13/16 BLISTER

8 pz mm 13  
4 pz mm 16

Colore bianco



203001

€ 3,36 blister

20

ny

### TACCHETTO NYLON MM 13

Confezione da 100 pz  
mm 13

Colore bianco



204001

€ 19,60 conf

1

ny

### TACCHETTO NYLON MM 16

Confezione da 100 pz  
mm 16

Colore bianco



205001

€ 19,60 conf

1

ny

### TACCHETTO NYLON MM 13/16 BLISTER

8 pz mm 13  
4 pz mm 16

Colore rosso



203004

€ 3,36 blister

20

ny

### TACCHETTO NYLON MM 13

Confezione da 100 pz  
mm 13

Colore rosso



204004

€ 19,60 conf

1

ny

### TACCHETTO NYLON MM 16

Confezione da 100 pz  
mm 16

Colore rosso



205004

€ 19,60 conf

1

ny

### TACCHETTO NYLON MM 13/16 BLISTER

8 pz mm 13  
4 pz mm 16

Colore nero



203007

€ 3,36 blister

20

ny

### TACCHETTO NYLON MM 13

Confezione da 100 pz  
mm 13

Colore nero



204007

€ 19,60 conf

1

ny

### TACCHETTO NYLON MM 16

Confezione da 100 pz  
mm 16

Colore nero



205007

€ 19,60 conf

1

ny

### TACCHETTO NYLON MM 13/16 BICOLORE BLISTER

8 pz mm 13  
4 pz mm 16

Scatola con blister di colori  
assortiti



206ASS

€ 4,48 blister

20

ny

TACCHETTO ALLUMINIO TORNITO  
PROFESSIONAL MM 11

Confezione da 50 pz  
mm 11



000250

€ 65,80 conf

1

alluminio

TACCHETTO ALLUMINIO CONICO MM 14

Confezione da 100 pz  
mm 14



000262

€ 36,40 conf

1

alluminio

TACCHETTO ALLUMINIO TORNITO  
PROFESSIONAL MM 13

Confezione da 50 pz  
mm 13



000251

€ 68,60 conf

1

alluminio

TACCHETTO ALLUMINIO CONICO MM 17

Confezione da 100 pz  
mm 17



000263

€ 37,80 conf

1

alluminio

TACCHETTO ALLUMINIO TORNITO  
PROFESSIONAL MM 15

Confezione da 50 pz  
mm 15



000252

€ 70,00 conf

1

alluminio

TACCHETTO ALLUMINIO CONICO MM 19

Confezione da 100 pz  
mm 19



000264

€ 39,20 conf

1

alluminio

TACCHETTO ALLUMINIO TORNITO  
PROFESSIONAL MM 17

Confezione da 50 pz  
mm 17



000253

€ 71,40 conf

1

alluminio

TACCHETTO ALLUMINIO CONICO MM 14/17  
BLISTER

8 pz mm 14  
4 pz mm 17



000260

€ 5,32 blister

20

alluminio

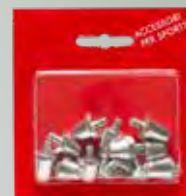

## TACCHETTO ALLUMINIO CONICO TORNITO MM 11/15 BLISTER

4 pz mm 11  
4 pz mm 13  
4 pz mm 15



000290

€ 10,64 blister

20

alluminio

## TACCHETTO ALLUMINIO CONICO TORNITO MM 11

Confezione da 100 pz  
mm 11



000292

€ 67,20 conf

1

alluminio

## TACCHETTO ALLUMINIO CONICO TORNITO MM 12

Confezione da 100 pz  
mm 12



000293

€ 72,80 conf

1

alluminio

## TACCHETTO ALLUMINIO CONICO TORNITO MM 11/15 + RONDELLE BLISTER

4 pz mm 11  
4 pz mm 13  
4 pz mm 15  
12 rondelle



000291

€ 12,60 blister

20

alluminio

## TACCHETTO ALLUMINIO CONICO TORNITO MM 13

Confezione da 100 pz  
mm 13



000294

€ 68,60 conf

1

alluminio

## TACCHETTO ALLUMINIO CONICO TORNITO MM 14

Confezione da 100 pz  
mm 14



000295

€ 68,60 conf

1

alluminio

## TACCHETTO ALLUMINIO CONICO TORNITO MM 19

Confezione da 100 pz  
mm 19



000300

€ 72,80 conf

1

alluminio

## TACCHETTO ALLUMINIO CONICO TORNITO MM 15

Confezione da 100 pz  
mm 15



000296

€ 70,00 conf

1

alluminio

## TACCHETTO ALLUMINIO CONICO TORNITO MM 16

Confezione da 100 pz  
mm 16



000297

€ 70,00 conf

1

alluminio

## TACCHETTO ALLUMINIO CONICO MM 14/17 + RONDELLE BLISTER

8 pz mm 14  
4 pz mm 17  
12 rondelle



000261

€ 7,56 blister

20

alluminio

## TACCHETTO ALLUMINIO CONICO TORNITO MM 17

Confezione da 100 pz  
mm 17



000298

€ 71,40 conf

1

alluminio

## TACCHETTO ALLUMINIO CONICO TORNITO MM 18

Confezione da 100 pz  
mm 18



000299

€ 71,40 conf

1

alluminio

**TACCHETTO ALLUMINIO TORNITO MM 9  
FILETTO MAGGIORATO**

 Confezione da 50 pz  
mm 9

255AD9

€ 75,60 conf

 1

alluminio

**TACCHETTO ALLUMINIO TORNITO MM 9/11  
FILETTO MAGGIORATO  
BLISTER**

 8 pz mm 9  
4 pz mm 11

259AD1

€ 17,36 blister

 1

alluminio

**TACCHETTO ALLUMINIO TORNITO MM 11  
FILETTO MAGGIORATO**

 Confezione da 50 pz  
mm 11

256AD1

€ 67,20 conf

 1

alluminio

**TACCHETTO ALLUMINIO TORNITO MM 11/13  
FILETTO MAGGIORATO  
BLISTER**

 8 pz mm 11  
4 pz mm 13

259AD3

€ 17,92 blister

 1

alluminio

**TACCHETTO ALLUMINIO TORNITO MM 13  
FILETTO MAGGIORATO**

 Confezione da 50 pz  
mm 13

257AD3

€ 68,60 conf

 1

alluminio

**TACCHETTO ALLUMINIO TORNITO MM 13/15  
FILETTO MAGGIORATO  
BLISTER**

 8 pz mm 13  
4 pz mm 15

259AD5

€ 18,48 blister

 1

alluminio

**TACCHETTO ALLUMINIO TORNITO MM 15  
FILETTO MAGGIORATO**

 Confezione da 50 pz  
mm 15

258AD5

€ 70,00 conf

 1

alluminio



## TACCHETTO ALLUMINIO CONICO MM 14 RONDELLE INCORPORATE

Confezione da 100 pz  
mm 14

000267

€ 44,80 conf

1

alluminio



## TACCHETTO ALLUMINIO CONICO MM 14/17 RONDELLE INCORPORATE BLISTER

8 pz mm 14  
4 pz mm 17

000265

€ 7,28 blister

20

alluminio



## TACCHETTO ALLUMINIO CONICO MM 17 RONDELLE INCORPORATE

Confezione da 100 pz  
mm 17

000268

€ 46,20 conf

1

alluminio



## TACCHETTO ALLUMINIO CONICO MM 17/19 RONDELLE INCORPORATE BLISTER

8 pz mm 17  
4 pz mm 19

000266

€ 7,98 blister

20

alluminio



## TACCHETTO ALLUMINIO CONICO MM 19 RONDELLE INCORPORATE

Confezione da 100 pz  
mm 19

000269

€ 47,60 conf

1

alluminio



## TACCHETTO RUGBY MM 18

16 pz mm 18

000280

€ 5,60 blister

20

alluminio



## TACCHETTO RUGBY MM 18

Confezione da 100 pz  
mm 18

000281

€ 22,40 conf

1

alluminio



**TACCHETTO ALLUMINIO METALLO TORNITO MM 11/16  
BLISTER**4 pz mm 11  
4 pz mm 13  
4 pz mm 16

000310

€ 9,52 blister

20

alluminio/metallo

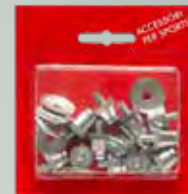
**TACCHETTO ALLUMINIO METALLO TORNITO MM 11/16  
+ RONDELLE  
BLISTER**4 pz mm 11  
4 pz mm 13  
4 pz mm 16  
12 rondelle

000311

€ 11,76 blister

20

alluminio/metallo

**TACCHETTO ALLUMINIO METALLO TORNITO MM 11**Confezione da 100 pz  
mm 11

000312

€ 70,00 conf

1

alluminio/metallo

**BORCHIE ACCIAIO ZINCATO**

Confezione da 50 pz per misura

mm 7  
mm 8  
mm 9  
mm 10  
mm 11  
mm 12

370001

€ 11,76 conf

1

acciaio zincocromato

**TACCHETTO ALLUMINIO METALLO TORNITO MM 13**Confezione da 100 pz  
mm 13

000313

€ 72,80 conf

1

alluminio/metallo

**BORCHIE IN LEGA LEGGERA 7/12**

Confezione da 50 pz per misura

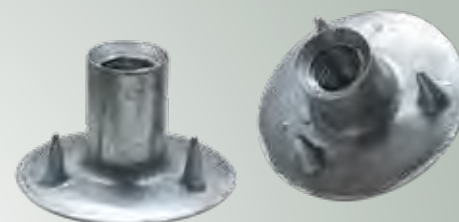
mm 7  
mm 8  
mm 9  
mm 10  
mm 11  
mm 12

370002

€ 12,60 conf

1

lega leggera

**TACCHETTO ALLUMINIO METALLO TORNITO MM 16**Confezione da 100 pz  
mm 16

000314

€ 75,60 conf

1

alluminio/metallo

**BORCHIE LEGA LEGGERA 13/17**

Confezione da 50 pz per misura

mm 13  
mm 14  
mm 17

370003

€ 18,76 conf

1

lega leggera

### TACCHETTI GOMMA BASE STRETTA MM 12/14 BLISTER

8 pz mm 12  
4 pz mm 14

321000

€ 7,28 blister

20

gomma



### RONDELLE ALLUMINIO SEMIBOMBATE

Confezione da 100 pz

000340

€ 9,80 conf

1

alluminio

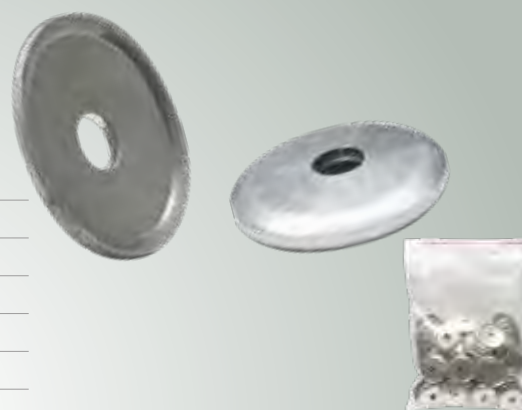

### TACCHETTI GOMMA BASE STRETTA MM 12

Confezione da 100 pz  
mm 12

321120

€ 47,60 conf

1

gomma



### CHIAVI PER TACCHETTI

Confezione da 10 pz

000350

€ 5,60 conf

1

acciaio



### TACCHETTI GOMMA BASE STRETTA MM 14

Confezione da 100 pz  
mm 14

321140

€ 47,60 conf

1

gomma



### TACCHETTI GOMMA BASE LARGA MM 11/13

8 pz mm 11  
4 pz mm 13

In gomma naturale vulcanizzata  
da usare esclusivamente per  
campi ghiacciati

322000

€ 11,20 conf

1

gomma naturale





SCocca RICAMBIO PER PANCHINA

Da utilizzare esclusivamente per le nostre panchine calcio e calcio pro



04595S
€ 24,00 cad
 1
pvc

STRUTTURA PER SEDUTE PANCHINA MT 1

Solo struttura  
Sedute escluse  
2 posti ogni metro



211100
€ 192,00 cad
 1
ferro

PANCHINA CALCIO PRO LX

Panchina allenatori calci curva  
Struttura in tubo di acciaio zincato smontabile  
Sedili in plastica  
Pannelli di rivestimento in policarbonato trasparente antiurto  
Curva molto ampia  
Profondità cm 180



4595L8
€ 7.500,00 cad
 1
mt 8
16 posti

4595L6
€ 5.790,00 cad
 1
mt 6
12 posti

4595L4
€ 4.080,00 cad
 1
mt 4
8 posti

### PANCHINA CALCIO

Struttura in tubo di alluminio mm 30x30

Pannelli di rivestimento  
in policarbonato alveolare  
traslucido con protezione anti-UV

Fianchi in policarbonato  
trasparente compatto antiurto

Sedili in plastica rossi



045931
€ 900,00 cad
 1
cm 106x75x205 h
2 posti

045932
€ 1.350,00 cad
 1
cm 206x75x205 h
4 posti

045933
€ 1.830,00 cad
 1
cm 306x75x205 h
6 posti

045934
€ 2.340,00 cad
 1
cm 406x75x205 h
8 posti

045935
€ 2.790,00 cad
 1
cm 506x75x205 h
10 posti

045936
€ 3.300,00 cad
 1
cm 606x75x205 h
12 posti

045937
€ 3.810,00 cad
 1
cm 706x75x205 h
14 posti

045938
€ 4.230,00 cad
 1
cm 806x75x205 h
16 posti

### PANCHINA CALCIO TRASPARENTE

Struttura in tubo di alluminio mm 30x30

Pannelli di rivestimento  
in policarbonato  
trasparente compatto  
antiurto con  
protezione anti-UV

Parte inferiore  
in resina melaminica

Sedili in plastica rossi



045951
€ 1.200,00 cad
 1
cm 106x75x205 h
2 posti

045952
€ 1.770,00 cad
 1
cm 206x75x205 h
4 posti

045953
€ 2.310,00 cad
 1
cm 306x75x205 h
6 posti

045954
€ 3.000,00 cad
 1
cm 406x75x205 h
8 posti

045955
€ 3.510,00 cad
 1
cm 506x75x205 h
10 posti

045956
€ 4.110,00 cad
 1
cm 606x75x205 h
12 posti

045957
€ 4.710,00 cad
 1
cm 706x75x205 h
14 posti

045958
€ 5.400,00 cad
 1
cm 806x75x205 h
16 posti



## PALLONE CALCIO PATHOS 5

Indicato per gare dilettantistiche e allenamento  
Pallone adatto per qualsiasi superficie di gioco  
e condizione atmosferica  
Materiale super resistente  
Gr 420

41 Rosso/bianco  
81 Royal/bianco



100006

€ 17,70 cad



1

misura 5

pu

## PALLONE CALCIO HYBRID 75 MIS 4

Cucito a macchina

new



210804

€ 15,40 cad



1

misura 4

pu

## PALLONE CALCIO PATHOS 4

Indicato per gare dilettantistiche e allenamento  
Pallone ideale per ragazzi  
Adatto per qualsiasi superficie di gioco  
e condizione atmosferica  
Materiale super resistente  
Gr 370

81 Royal/bianco  
41 Rosso/bianco



100007

€ 17,70 cad



1

misura 4

pu

## PALLONE CALCIO V41

Con valvola rigonfiabile  
Peso gr 360  
Ø 19,5 cm



100066

€ 12,80 cad

1

misura 4

gomma sintetica

## PALLONE CALCIO HYBRID 75 MIS 3

Cucito a macchina



210703

€ 15,40 cad

1

misura 3

pu

## PALLONE CALCIO V42

Con valvola rigonfiabile  
Peso gr 300  
Ø 18 cm



100067

€ 12,48 cad

1

misura 3

gomma sintetica

## PALLONE SONORO CALCIO TORBALL

**new**



211200

€ 66,36 cad

1

## PALLONE CALCIO V44

Con valvola rigonfiabile  
Peso gr 290  
Ø 16 cm



100068

€ 12,16 cad

1

misura 2

gomma sintetica

## PALLONE SOFT CALCIO 200

Indicato per attività didattica  
Ø 20



007852

€ 7,68 cad

1

misura 3

spugna



## FOOTBALL TRAINER

Pallone escluso

**new**



200410

€ 16,60 cad

1

LAVAGNA CALCIO GRANDE

Magnetica  
Pedine comprese  
Pennarello incluso



FA0060

€ 67,50 cad

1

cm 90x60

LAVAGNA CALCIO PICCOLA MAGNETICA

Lavagna calcio a 11 con  
custodia in pelle sintetica  
Pedine e pennarello inclusi



46890C

€ 27,80 cad

1

cm 20x28,5

pvc

LAVAGNA CALCIO MEDIA

Magnetica  
Pedine comprese  
Pennarello incluso



FA0070

€ 55,00 cad

1

cm 60x45

LAVAGNA CALCIO PICCOLA REVERSIBILE



24371C

€ 14,85 cad

1

cm 34,2x22,9

pvc

LAVAGNA CALCIO PICCOLA

Senza pedine  
Pennarello incluso



FA0090

€ 14,40 cad

1

cm 40x23

## GANCIO APERTO

Per porte calcio  
Venduto in confezioni  
da 100 ganci



4580GP

€ 0,92 cad

100

ny

## PARASTINCHI HAWK

Cavigliera staccabile



OUTLET  
per esaurimento scorte

181300

€ 5,60 paio

1

man - boy - kid

## GANCIO CHIUSO

Per porte calcio  
Venduto in confezioni  
da 100 ganci



4580NW

€ 0,92 cad

100

ny

## GANCIO CON VITE

Per porte calcio  
Viti comprese  
Venduto in confezioni  
da 100 ganci



160353

€ 1,18 cad

100

ny

## GANCIO APERTO VERDE PER PORTE CALCIO

new



200001

€ 1,28 cad

100

ny

**PORTE CALCIO TRASPORTABILI PRO**

Pali traversa e base di appoggio  
in lega leggera  
a sezione ovoidale  
mm 100x120  
Autoportanti  
A norme UNI EN 748  
Reti escluse



045804

€ 3'480,00 coppia

1

cm 732x244

lega leggera

**PORTE CALCIO FISSE**

In lega leggera a sezione ovoidale  
mm 100x120  
Complete di boccole da interrare  
Sostegni posteriori  
reggire in acciaio  
A norme UNI 748  
Traversa divisa



004580

€ 1'995,00 coppia

1

cm 732x244

lega leggera

**PORTE CALCIO TRASPORTABILI**

In lega leggera a sezione ovoidale mm 100x120  
Autoportanti  
Base di appoggio a terra  
e sostegni posteriori reggire in acciaio  
A norme UNI EN 748  
Reti escluse



45804F

€ 2.424,00 coppia

1

cm 732x244

lega

**RIBALTINE ALZARETE ACCIAIO**

Ribaltina alzarete per porte calcio regolamentari  
In acciaio zincato  
Profondità cm 157 con snodi da fissare  
posteriormente alla base dei pali per permettere  
di alzare la rete in fase di manutenzione del  
prato

**Altre misure prezzo a preventivo**

4580RI

€ 462,00 coppia

1

acciaio zincato



**RUOTE PER PORTE A SEZIONE OVOIDALE**

Con staffe di fissaggio  
Da utilizzare esclusivamente  
per porte con pali  
a sezione ovoidale  
mm 100x120



45804R

€ 240,00 coppia

1

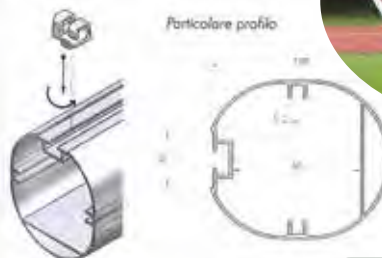

LE PORTE  
TRASPORTABILI  
SI VENDONO ANCHE  
SINGOLARMENTE



## RETE CALCIO REGOLAMENTARE C16

Maglia quadra annodata mm130

Ø 4,5 mm



C00160

€ 287,97 coppia

1

cm 750x250

pe

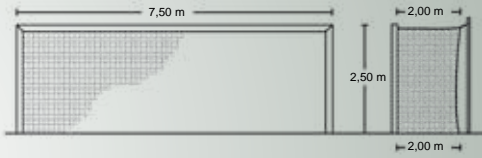

## RETE CALCIO REGOLAMENTARE C04

Maglia esagonale mm120

Ø 4 mm



00C004

€ 242,46 coppia

1

cm 750x250

ppht

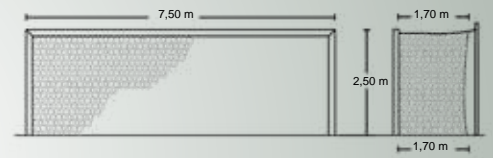

## RETE CALCIO REGOLAMENTARE C18

Maglia quadra annodata mm130

Ø 3,5 mm



0C0018

€ 197,76 coppia

1

cm 750x250

pe

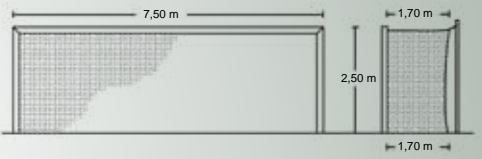

## RETE CALCIO REGOLAMENTARE C19

Maglia quadra annodata mm130  
Ideale per porte trasportabili

Ø 3,5 mm



0C0019

€ 194,69 coppia

1

cm 750x250

pe

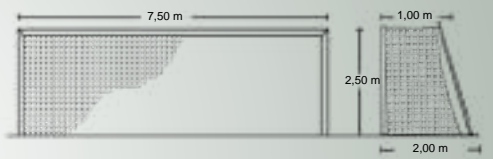

## RETE CALCIO REGOLAMENTARE C24

Maglia quadra annodata mm 130

Ø 3,5 mm



- 28 Giallo/royal
- 49 Rosso/blu
- 14 Bianco/rosso
- 17 Bianco/nero
- 18 Bianco/royal
- 16 Bianco/verde

0C0024

€ 207,94 coppia

1

cm 750x250

pe



28

49

14

17

18

16

**PORTE 6x2 TRASPORTABILI PRO**

Pali traversa e base di appoggio  
in lega leggera  
a sezione ovoidale  
mm 100x120  
Autoportanti  
A norme UNI EN 748  
Reti escluse



458006

€ 3'090,00 coppia

1

cm 600x200

lega leggera

**RETE CALCIO 6x2**

Maglia quadra annodata mm130  
Ideale per porte trasportabili

Ø 3,5 mm



000170

€ 131,26 coppia

1

cm 600x200

pe

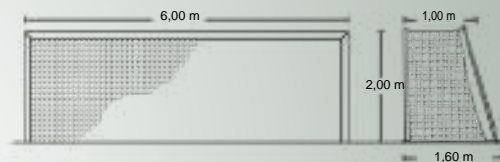

**PORTE 6x2 TRASPORTABILI**

In lega leggera a sezione ovoidale mm 100x120  
Traversa divisa  
Base di appoggio a terra  
e sostegni posteriori  
reggiate in acciaio  
Autoportanti  
Reti escluse



04581T

€ 2.229,00 coppia

1

cm 600x200

lega

**RETE CALCIO 6x2**

Maglia esagonale mm120

Ø 4 mm



000154

€ 170,88 coppia

1

cm 600x200

ppht

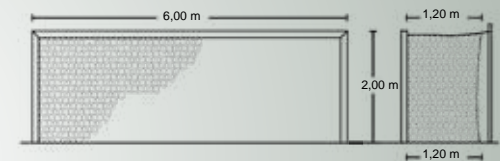

**PORTE 6x2 FISSE**

In lega leggera a sezione ovoidale  
mm 100x120  
Complete di bossole da interrare  
Sostegni posteriori  
reggiate in acciaio  
Traversa divisa

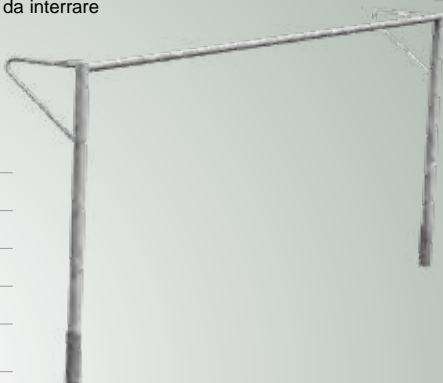

458100

€ 1'815,00 coppia

1

cm 600x200

lega

**RETE CALCIO 6x2 ECONOMICA**

Maglia esagonale mm130

Ø 2,5 mm



169000

€ 105,50 coppia

1

cm 600x200

pe

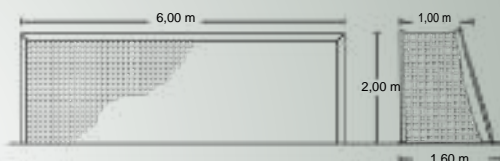

**RETE CALCIO 6,5x2,5**

Maglia esagonale mm120  
Per porte fuori misura

Ø 4 mm



153000

€ 207,04 coppia

1

cm 650x250

pe



**RETE CALCIO 6x2.2**

Maglia esagonale mm120  
Per porte fuori misura

Ø 4 mm



170200

€ 141,79 coppia

1

cm 600x220

pe

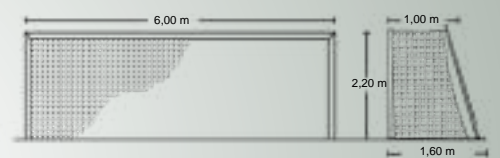

## PORTE 5x2 TRASPORTABILI

In lega leggera  
a sezione rotonda mm 80  
Traversa divisa  
Base di appoggio a terra  
e sostegni posteriori  
reggiate in acciaio  
Autoportanti  
Reti escluse

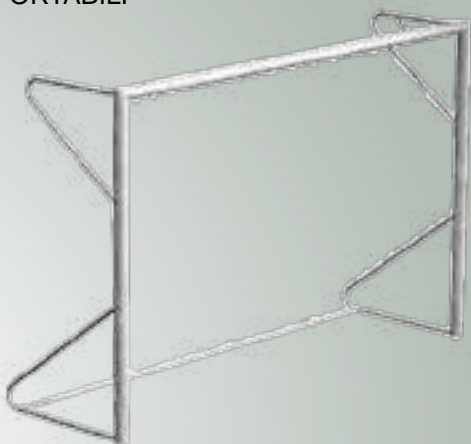

46445T

€ 1.320,00 coppia

1

cm 500x200

lega

## RETE CALCIO 5x2

Maglia quadra annodata mm130  
Ideale per porte trasportabili

Ø 3,5 mm



000171

€ 120,06 coppia

1

cm 500x200

pe

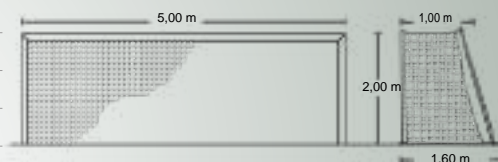

## RUOTE PER PORTE A SEZIONE ROTONDA

Da utilizzare esclusivamente  
per porte con pali  
a sezione rotonda mm 80  
Fissaggio con perno



04640R

€ 93,00 coppia

1

## RETE CALCIO 5x2

Maglia esagonale mm120

Ø 4 mm



000155

€ 152,38 coppia

1

cm 500x200

ppht

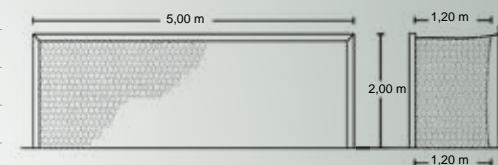

## SACCA PER SABBIA

Sacca vuota da riempire  
con sabbia  
Per la sicurezza consigliate  
3 sacche per singola porta



FA0260

€ 24,30 cad

1

## RETE CALCIO 5x2 ECONOMICA

Maglia quadra annodata mm130  
Ideale per porte trasportabili

Ø 2,5 mm



168000

€ 98,02 coppia

1

cm 500x200

pe

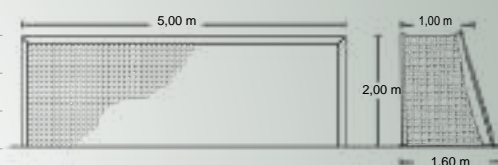

## PORTE 5x2 FISSE

In lega leggera a sezione ovoidale  
mm 100x120  
Complete di bossole da interrare  
Sostegni posteriori  
reggiate in acciaio  
Traversa intera

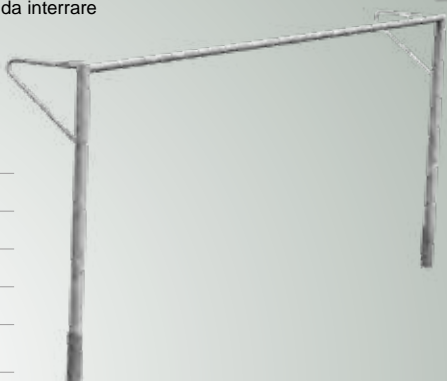

458200

€ 1'650,00 coppia

1

cm 500x200

lega

**PORTE 4x2 - LEGA**

In lega leggera  
a sezione rotonda mm 80  
Base di appoggio a terra  
e sostegni posteriori  
reggirete in acciaio  
Autoportanti  
Reti escluse

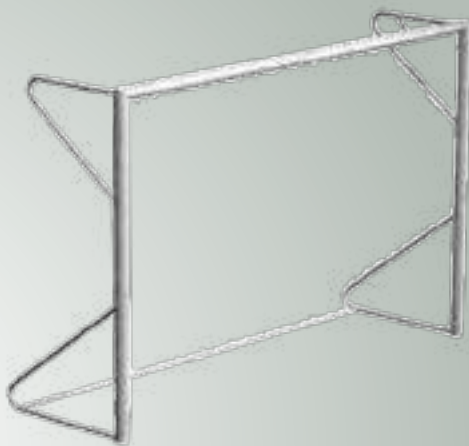

004644

€ 1.182,00 coppia

1

cm 400x200

lega

**RETE CALCETTO 4x2**

Maglia quadra annodata mm130

Ø 3,5 mm



000166

€ 106,50 coppia

1

cm 400x200

pe

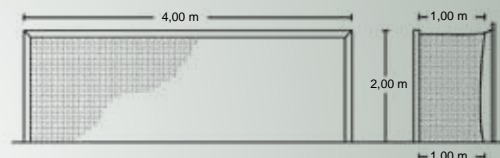

**PORTE 4x2 - ACCIAIO**

In acciaio verniciato  
a sezione rotonda mm 80  
Base di appoggio a terra  
e sostegni posteriori  
reggirete in acciaio  
Autoportanti  
Reti escluse

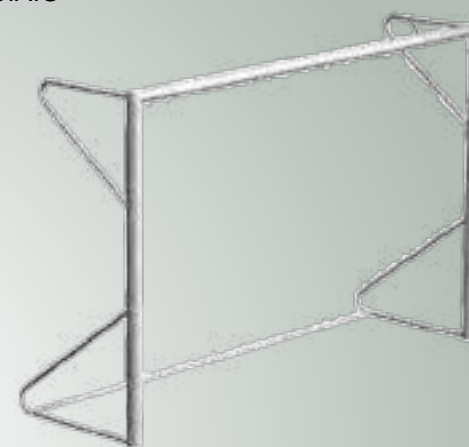

004643

€ 909,00 coppia

1

cm 400x200

acciaio

**RETE CALCETTO 4x2**

Maglia esagonale mm100

Ø 4 mm



000156

€ 125,73 coppia

1

cm 400x200

ppht

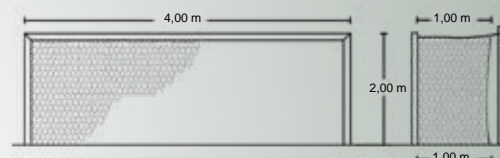

**PORTE 4x2 FISSE**

In acciaio verniciato  
a sezione rotonda mm 80  
Sostegni posteriori  
reggirete in acciaio  
Con bossole da interrare  
Traversa intera  
Reti escluse



04643B

€ 1'092,00 coppia

1

cm 400x200

acciaio

**RETE CALCETTO 4x2 ECONOMICA**

Maglia quadra annodata mm130

Ø 2,5 mm



167000

€ 82,43 coppia

1

cm 400x200

pe

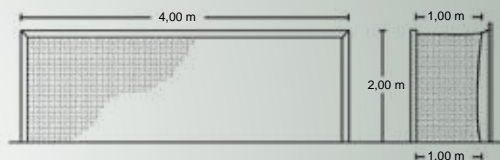

**PORTE 4x2 FISSE**

In lega leggera  
a sezione rotonda mm 80  
Sostegni posteriori  
reggirete in acciaio  
Con bossole da interrare  
Traversa intera  
Reti escluse



04644B

€ 1'230,00 coppia

1

cm 400x200

lega

## RUOTE PER PORTE A SEZIONE ROTONDA

Da utilizzare esclusivamente per porte con pali a sezione rotonda mm 80  
Fissaggio con perno



04640R

€ 93,00 coppia

1

## PROTEZIONE RIBALTINA KIT 12 PZ

Protezione tubolare per ribaltina alzarete  
Materiale espanso rivestito  
Dimensione modulo cm 200

Colore bianco



4580RP

€ 144,00 kit

1

cm 200x12 pz

espanso rivestito

## SACCA PER SABBIA

Sacca vuota da riempire con sabbia  
Per la sicurezza consigliate 3 sacche per singola porta



FA0260

€ 24,30 cad

1

## RETE PROTEZIONE CAMPI MM 100

Prezzo al metro quadro con corda perimetrale  
Larghezza quadro rete mm 100



430100

€ 3,04 mq



misure a richiesta

pe

## RETE PROTEZIONE CAMPI MM 45

Prezzo al metro quadro con bordatura perimetrale  
Larghezza quadro rete mm 45  
Diametro mm 3

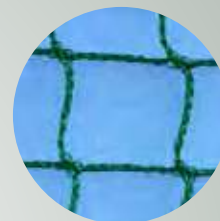

440045

€ 5,22 mq



misure a richiesta

pe

## RETE PROTEZIONE CAMPI MM 140

Prezzo al metro quadro con bordatura perimetrale  
Larghezza quadro rete mm 140



460140

€ 2,50 mq



misure a richiesta

pe

**PORTE 3x2 - LEGA**

In lega leggera  
a sezione rotonda mm 80  
Base di appoggio a terra  
e sostegni posteriori  
reggiate in acciaio  
Autoportanti  
Reti escluse



004642

€ 1.104,00 coppia

1

cm 300x200

lega

**RETE CALCETTO 3x2**

Maglia quadra annodata mm100

Ø 3,5 mm



000159

€ 101,41 coppia

1

cm 300x200

pe

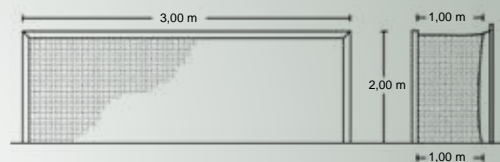

**PORTE 3x2 - ACCIAIO**

In acciaio verniciato  
a sezione rotonda mm 80  
Base di appoggio a terra  
e sostegni posteriori  
reggiate in acciaio  
Autoportanti  
Reti escluse



004640

€ 831,00 coppia

1

cm 300x200

acciaio

**RETE CALCETTO 3x2**

Maglia esagonale mm100

Ø 4 mm



000150

€ 105,50 coppia

1

cm 300x200

ppht

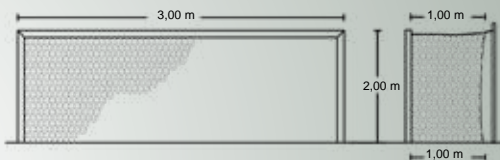

**PORTE 3x2 FISSE**

In acciaio verniciato  
a sezione rotonda mm 80  
Sostegni posteriori  
reggiate in acciaio  
Con bossole da interrare  
Traversa intera  
Reti escluse



04640B

€ 870,00 coppia

1

cm 300x200

acciaio

**RETE CALCETTO 3x2 ECONOMICA**

Maglia quadra annodata mm100

Ø 2,5 mm



149000

€ 79,36 coppia

1

cm 300x200

pe

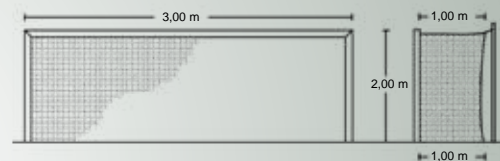

**PORTE 3x2 FISSE**

In lega leggera  
a sezione rotonda mm 80  
Sostegni posteriori  
reggiate in acciaio  
Con bossole da interrare  
Traversa intera  
Reti escluse



04642B

€ 1'239,00 coppia

1

cm 300x200

lega

**RUOTE PER PORTE A SEZIONE ROTONDA**

Da utilizzare esclusivamente  
per porte con pali  
a sezione rotonda mm 80  
Fissaggio con perno



04640R

€ 93,00 coppia

1

## PALLONE FUTSAL METEOR

Indicato per l'allenamento e gare indoor e outdoor  
Rimbalo controllato  
Gr 400-440



013605

€ 30,72 cad

1

misura 4

tpu soft

## LAVAGNA FUTSAL PICCOLA REVERSIBILE

Disponibile in 2 colori  
Rosso e giallo



**new**

24373F

€ 14,85 cad

1

cm 34,2x22,9

pvc

## PALLONE FUTSAL VENUS

Indicato per l'allenamento outdoor  
Rimbalo controllato  
Gr 400-440



136770

€ 22,29 cad

1

misura 4

pu

## LAVAGNA FUTSAL PICCOLA MAGNETICA

Lavagna futsal/pallamano con  
custodia in pelle sintetica  
Pedine e pennarello inclusi

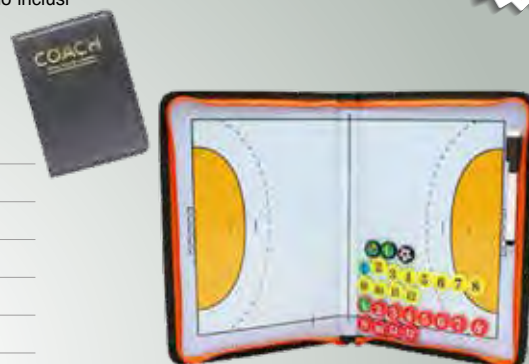

**new**

46920F

€ 27,80 cad

1

cm 21,5x28,5

pvc

## PALLONE FUTSAL DERBY

Indicato per l'attività giovanile  
Rimbalo controllato  
Gr 360-390



**OUTLET**  
fino al esaurimento scorte

013516

€ 21,10 cad

1

misura 3

tpu

## SACCA PER SABBIA

Sacca vuota da riempire  
con sabbia  
Per la sicurezza consigliate  
3 sacche per singola porta

**new**



FA0260

€ 24,30 cad

1

## PALLONE FUTSAL GOMMA

Rigonfiabili e indeformabili  
Valvola in gomma naturale vulcanizzata  
Indicato per l'attività scolastica ufficiale  
Rispetta le disposizioni FIGC  
Approvati FIGC settore giovanile e scolastico  
A rimbalo controllato entro 60 cm  
Non tossico - senza lattice  
Gr 380  
Ø 20 cm



100073

€ 23,04 cad

1

misura 3

gomma doppio strato

**PORTICINA QUICK FIRE 240**

Porta da calcio trasportabile e molto facile da montare  
 Perfetta per campi da calcio, palestre e giardini  
 Resistente a tutte le temperature meteorologiche  
 Utilizzabile anche come rebounder

Borsa per il trasporto e rete incluse



FGM380
€ 172,80 cad
1
cm 240x150 h
acciaio

**PORTICINA SOCCER GOAL 120**



150110
€ 82,19 cad
1
cm 120x60 h
ferro verniciato

**PORTICINA QUICK FIRE 300**

Porta da calcio trasportabile e molto facile da montare  
 Perfetta per campi da calcio, palestre e giardini  
 Resistente a tutte le temperature meteorologiche  
 Utilizzabile anche come rebounder

Borsa per il trasporto e rete incluse



FGM390
€ 192,00 cad
1
cm 300x200 h
acciaio

**PORTICINA SOCCER GOAL 170**



150120
€ 106,20 cad
1
cm 170x110 h
ferro verniciato

**PORTICINE POP-UP**

Porte leggere e facili da trasportare  
 Dopo il primo assemblaggio si possono piegare in 2 per poi  
 dispiegarle con grande facilità e ricominciare ad utilizzarle

Borsa per il trasporto e reti incluse



FGM230
€ 72,00 coppia
1
cm 120x90 h
acciaio

**PORTICINE POP-UP SOCCER GOAL**



350010
€ 47,81 coppia
1
cm 120x86 h

## PORTICINA PRO 150x110

Tubo ø 80 mm  
Inclusa rete



000214

€ 304,80 cad

1

cm 150x110 h

ferro verniciato

## PORTICINA PRO PLASTICA

Porte da calcio in u-pvc solido e flessibile  
ø pali 68mm  
Le diverse parti si uniscono tra loro mediante il clicksystem  
Facile da montare e trasportare

Rete, ganci di fissaggio e ancoraggi a terra inclusi



FGM00U

€ 122,40 cad

1

cm 150x120 h

u-pvc

## PORTICINA PRO 90x60

Tubo ø 80 mm  
Inclusa rete



180218

€ 240,22 cad

1

cm 90x60 h

ferro verniciato

## PORTICINA PRO PLASTICA

Porte da calcio in u-pvc solido e flessibile  
ø pali 68mm  
Le diverse parti si uniscono tra loro mediante il clicksystem  
Facile da montare e trasportare

Rete, ganci di fissaggio e ancoraggi a terra inclusi



FGM020

€ 172,80 cad

1

cm 240x180 h

u-pvc

## PORTICINA FERRO 150x110

Tubo ø 30  
Inclusa rete



000215

€ 110,88 cad

1

cm 150x110 h

ferro verniciato

## PORTICINA CON SUPPORTO

Tubo ø 40  
Capovolta si ottiene  
una porticina 150x80 h

Rete inclusa



00061F

€ 98,08 cad

1

cm 150x110 h

pvc

## PORTICINA FERRO 90x60

Tubo ø 30  
Inclusa rete



150217

€ 93,57 cad

1

cm 90x60 h

ferro verniciato



## MATERASSO H5

Per allenamento portieri

200100

€ 198,00 cad



1

cm 200x100x5 h

gommapiuma / pvc



## FODERE

Per fodere antiscivolo prezzo a preventivo  
Antibatterico, antimuffa, ignifugo cl.2

203300

€ 112,50 cad



1

cm 200x100x5 h

pvc

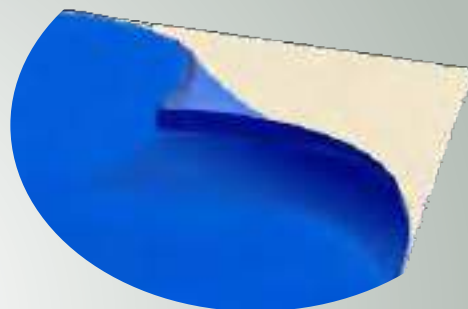

## PALLONE REACTION BALL

Ideale per allenamento di calcio,  
pallavolo, basket e pallamano  
Stimola la capacità di reazione coordinativa  
Non tossico - senza lattice  
Gr 420  
Ø 21,5 cm

130002

€ 30,72 cad



1

gomma doppio strato



## MATERASSO H10

Per allenamento portieri

200200

€ 234,30 cad



1

cm 200x100x10 h

gommapiuma / pvc



## GUANTO PORTIERE HAWK



100100

€ 8,40 paio



1

6 - 7 - 8 - 9

lattice

OUTLET  
preparimento scorte

## FODERE

Per fodere antiscivolo prezzo a preventivo  
Antibatterico, antimuffa, ignifugo cl.2

203400

€ 123,00 cad



1

cm 200x100x10 h

pvc

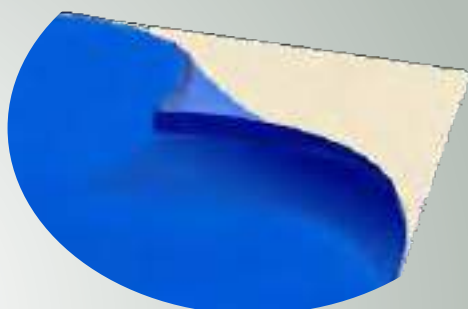

## TELAIO GK ZINCATO

Inclinazione regolabile



203012

€ 199,39 cad

1

cm 120x120

ferro zincato

## TELAIO GK CON MANIGLIE

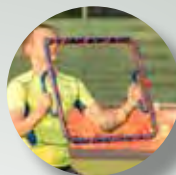

202955

€ 72,38 cad

1

cm 55x55

ferro verniciato

## TELAIO PORTIERE 130

Per allenamento portieri e giocatori Kg 7



105030

€ 166,40 cad

1

cm 130x130

ferro verniciato

## ELASTICO ALLENAMENTO PORTIERI

Questo articolo è perfetto per l'allenamento dei portieri calcio L'elastico si lega intorno al portiere e ai pali della porta



FA0600

€ 95,40 cad

1

cm 150

elastico



## TELAIO PORTIERE CON MANIGLIE PRO

Ad inclinazione regolabile con maniglie impugnabili Consente la simulazione di colpi di testa e tiri acrobatici per allenamento portieri



05030T

€ 204,90 cad

1

cm 90x70

alluminio

## TELAIO TCHOUKBALL



TA087F

€ 162,00 cad

1

cm 100x100

metallo

**PALLONE VOLLEY 5000**

Pallone ufficiale della Federazione Italiana Pallavolo  
Erede del "Soft Touch"  
Gr. 260-280  
Circonferenza 65-67 cm  
Pallone omologato FIVB Approved

VM5000
€ 93,60 cad
 1
misura 5
pu microfibra

**PALLONE VOLLEY 4000**

Pallone indicato per l'allenamento professionale e attività scolastica  
Gr. 260-280

VM4000
€ 76,18 cad
 1
misura 5
pu microfibra

**PALLONE VOLLEY SCHOOL**

Indicato per scuole e categorie giovanili  
Gr 230-250

013066
€ 22,08 cad
 1 / 24
misura 5
pvc soft

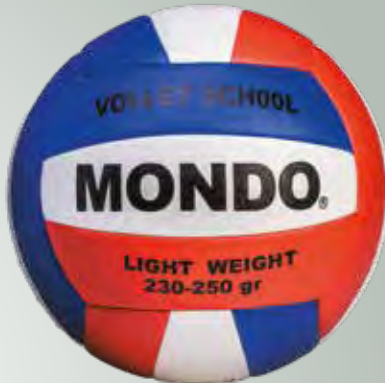
**PALLONE VOLLEY SCHOOL 2501**

Omologato e ufficiale Fipav  
Campionato Under13 e Attività scolastica  
Gr 230 - 250

VM2501
€ 35,10 cad
 1
misura 5
tpu



## PALLONE SUPERMINIVOLLEY V27

Con valvolina rigonfiabile  
Gr 250  
Ø 20,5 cm



100085

€ 10,56 cad

1

misura 5

gomma sintetica

## SEGNAPUNTI DA TAVOLO VOLLEY

Numeri da 0 a 50



053010

€ 56,67 cad

1

cm 55x30 h

## PALLONE MINIVOLLEY V33

Con valvolina rigonfiabile  
Gr 200  
Ø 20,5 cm



100084

€ 10,56 cad

1

misura 5

gomma sintetica

## PALETTE SOSTITUZIONE GIOCATORI

Kit 18 pezzi

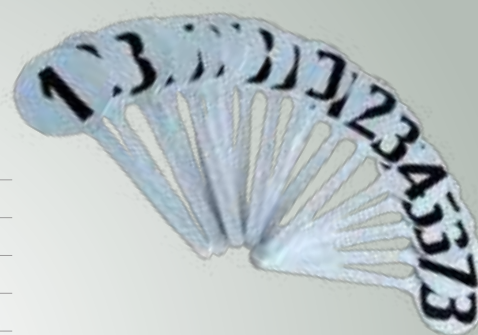

006784

€ 210,00 kit

1

## PALLONE VOLLEY SOFT BV20

Pallone volley super soffice  
per avviamento  
Per attività senso-percettive e  
di coordinazione  
Gr 220



100086

€ 22,40 cad

1

gr 220

gomma sintetica

## BORSA PORTA PALETTE CON BASE



006786

€ 109,20 cad

1

**RETE VOLLEY PRO**

Maglia quadra annodata mm 100  $\varnothing$  3,5 mm  
 Nella parte superiore cavo di acciaio  
 ricoperto da banda doppia in pvc color bianco cm 7  
 Nella parte inferiore banda cm 5 attraverso la quale  
 passa una corda che la mantiene tesa e la fissa ai pali  
 Lateralmente una fettuccia di 3 cm di colore nero  
 custodisce le stecche di tensione  
 Completa di antenne e tasche  
 A norma FIPAV

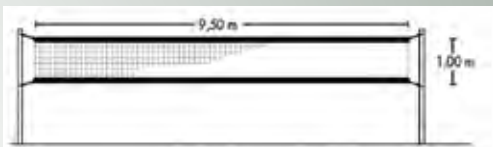

00P200  
 € 220,13 cad  
 1  
 cm 950x100 h  
 pe

**ARGANELLO A CRICCHETTO**

Ricambio per  
 impianto volley 06746T

676700  
 € 56,00 cad  
 1

**RETE VOLLEY ECO**

Maglia quadra annodata mm 100  $\varnothing$  2,5 mm  
 Nella parte superiore cavo di acciaio  
 ricoperto da banda in pvc cm 5

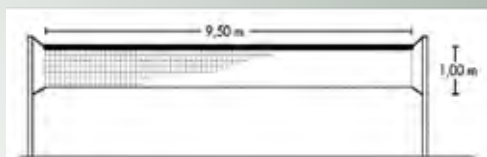

00P090  
 € 80,99 cad  
 1  
 cm 950x100 h  
 pe

**ARGANELLO A CREMAGLIERA**

Ricambio per  
 impianto volley 006748  
 Completo di maniglia

676710  
 € 176,00 cad  
 1

**RETE SUPER MINIVOLLEY**

Maglia quadra mm 100  
 $\varnothing$  mm 2,5  
 Banda colorata in polipropilene cm 4 parte superiore  
 Bordatura laterale di rinforzo

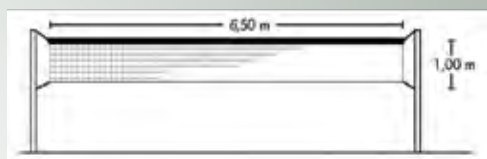

00P140  
 € 33,92 cad  
 1  
 cm 650x100 h  
 pp

**ANTENNE VOLLEY SMONTABILI**

000P14  
 € 40,70 coppia  
 1  
 vetroresina

**RETE MINIVOLLEY**

Maglia quadra mm 100  
 $\varnothing$  mm 2,5  
 Banda colorata in polipropilene cm 4 parte superiore  
 Bordatura laterale di rinforzo

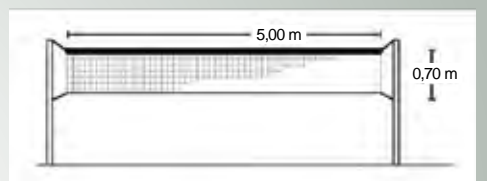

00P130  
 € 27,14 cad  
 1  
 cm 500x70 h  
 pp

**TASCHE PORTA ANTENNE VOLLEY**

000P15  
 € 15,94 coppia  
 1



## IMPIANTO VOLLEY TRALICCIO

Tubo di alluminio a sezione ovoidale mm 122x103  
Rinforzato internamente  
Con tendirete a cremagliera interno al palo  
Fissaggio a terra con tirafondi  
Modello omologabile antinfortunistico



006748

€ 1.408,00 cad

1

alluminio

## PROTEZIONE IMPIANTO VOLLEY TRALICCIO

Imbottitura di protezione  
per impianto volley a traliccio art. 006748  
In eliocell espanso  
Con rivestimento in pvc  
Chiusura con velcro



223600

€ 750,00 coppia

1

h 200 cm

eliocell espanso / pvc

## IMPIANTO VOLLEY FISSO ACCIAIO

Con bossole da interrare  
Formato da 2 montanti in tubo di acciaio zincato  
Diametro mm 76 altezza cm 255 fuori terra  
Tendirete a cricchetto  
Utilizzabile anche per tennis



Rete esclusa

06746T

€ 342,40 cad

1

acciaio

## PROTEZIONE IMPIANTO VOLLEY FISSO

Imbottitura di protezione  
per impianto volley art. 06746T  
In eliocell espanso  
Con rivestimento in pvc  
Chiusura con velcro



208300

€ 600,00 coppia

1

h 200 ø 12 cm

eliocell espanso / pvc

## IMPIANTO VOLLEY TORNEO

Impianto formato da 2 montanti a traliccio in acciaio  
verniciato con doppia controvenatura  
Palo di scorrimento zincato  
Completo di tendirete a cricchetto  
Fissaggio a pavimento con attacchi a vite



Rete esclusa

006740

€ 800,00 cad

1

acciaio

## IMPIANTO VOLLEY A PARETE

Impianto pallavolo a parete  
in tubo di acciaio zincato  
Predisposto con piastre per  
il fissaggio a tasselli



Rete esclusa

06752T

€ 336,00 cad

1

acciaio zincato

## IMPIANTO MINIVOLLEY - BADMINTON

Trasportabile su ruote  
Zavorrato



006780

€ 464,00 cad

1

## PROTEZIONE MULTIFUNZIONE

Chiusura con velcro

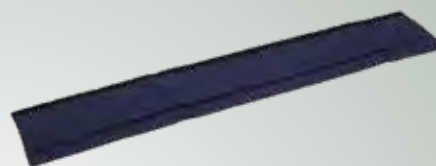

OUTLET  
utili per esaurimento scorte

ZY20CV

€ 45,00 cad

1

cm 180x27x2

**PALCHETTO ARBITRO VOLLEY (T)**

Palchetto per arbitro pallavolo  
Struttura in tubo di acciaio verniciato  
Smontabile  
Con ruote per il trasporto



006768

€ 512,00 cad

1

h 200 ø 12 cm

**PALCHETTO ARBITRO VOLLEY SPECIAL**

Palchetto per arbitro pallavolo seduto  
ed in piedi  
Struttura in tubo di acciaio verniciato  
Smontabile  
Con ruote per il trasporto



06768S

€ 736,00 cad

1

h 200 ø 12 cm

**AVVOLGIRETE VOLLEY**

Attrezzo che permette di avvolgere perfettamente la rete  
Struttura in tubo di acciaio verniciato con ruote

Rete esclusa



675600

€ 169,60 cad

1

acciaio verniciato

**CAVO ACCIAIO**

Cavetto in acciaio per ricambio su reti da volley



P18000

€ 16,96 cad

1

cm 40x23

acciaio

**BALL-CATCHER**

Contenitore porta palloni incluso  
Altezza regolabile da cm 170 a 300  
Canestro inclinabile



675300

€ 544,00 cad

1

cm 170/300

ferro verniciato

## IMPIANTO TRASPORTABILE MULTISPORT

Il set include 3 diverse reti: 1 tennis, 1 badminton e  
1 volley + 2 tubi estensibili  
La scatola funge da ancoraggio per i tubi  
Rete tennis: 2,45x1,05 m  
Rete badminton: 3,2x1,5 m  
Rete volley: 3,02x2,24 m

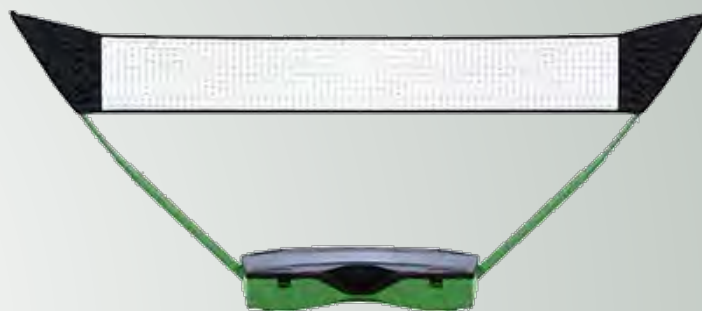

641700
€ 132,84 kit
1
pc

## LAVAGNA VOLLEY PICCOLA MAGNETICA

Lavagna volley  
Pedine e pennarello inclusi



46910V
€ 27,80 cad
1
cm 40x29
pvc

## LAVAGNA VOLLEY

Senza pedine  
Pennarello incluso



100003
€ 20,00 cad
1
cm 40x23
materiale plastico



**PALLONE BASKET GM7X**

Pallone omologato FIBA Official Sponsor  
 Pallone ufficiale della FIP Comitati  
 Regionali, Provinciali e Giovanili Maschili  
 Ottimo anche per uso outdoor  
 Gr 567-650  
 Ex BGM7X

BG3800
€ 72,80 cad
 1
misura 7
pu

**PALLONE BASKET GR5**

Pallone ufficiale della FIP  
 per mini basket  
 Gr 470-500  
 Ex BGR50I

BG1600
€ 27,30 cad
 1
misura 5
pu

**SEGNAPUNTI BASKET DA TAVOLO**

Numeri da 0 a 19

053008
€ 47,46 cad
 1
cm 55x22x29 h

**PALLONE BASKET EASY 4**

Pallone ufficiale della FIP per l'attività  
 Easy Basket  
 Gomma speciale di alta qualità  
 Eccezionale aderenza nella presa  
 Copertura di lunga durata  
 Circonferenza 65-67 cm  
 Gr. 280-300

SB4Y00
€ 29,90 cad
 1
misura 4
pu



## PALLONE BASKET SB PRO 7

Pallone ad elevato grip  
Indicato per categorie  
senior e giovanili  
Gr 570-650



013733

€ 21,76 cad

1

misura 7

gomma multistrato

## LAVAGNA BASKET - GRANDE

Lavagna basket ideale per  
l'organizzazione del piano  
tattico prima della partita

Pedine comprese  
Pennarello incluso



BBA050

€ 67,50 cad

1

cm 90x60

materiale plastico

## PALLONE MINIBASKET SB PRO 5

Pallone ad elevato grip  
Indicato per  
categorie giovanili  
Gr 470-500



013734

€ 21,12 cad

1

misura 5

gomma multistrato

## LAVAGNA BASKET PICCOLA

Senza pedine  
Pennarello incluso



BBA060

€ 14,40 cad

1

cm 40x23

materiale plastico

## PALLONE MINIBASKET MB 4

Pallone indicato per le  
scuole di minibasket  
Gr 370-390



139310

€ 17,60 cad

1

misura 4

ny gomma

## LAVAGNA BASKET PICCOLA REVERSIBILE



24372B

€ 14,85 cad

1

cm 22,9x34,2

pvc

## LAVAGNA BASKET PICCOLA MAGNETICA



Lavagna basket con  
custodia in pelle sintetica  
Pedine e pennarello inclusi



46900B

€ 27,80 cad

1

cm 21,5x25,5

pvc

**SAGOMA BASKET H 198/240**

Sagome per allenamento basket

Aiuta i giocatori a migliorare le loro capacità offensive

Base pesante e antiscivolo per garantire la sicurezza dei giocatori

Facile da trasportare e montare

Regolabile

Base e palo slalom inclusi

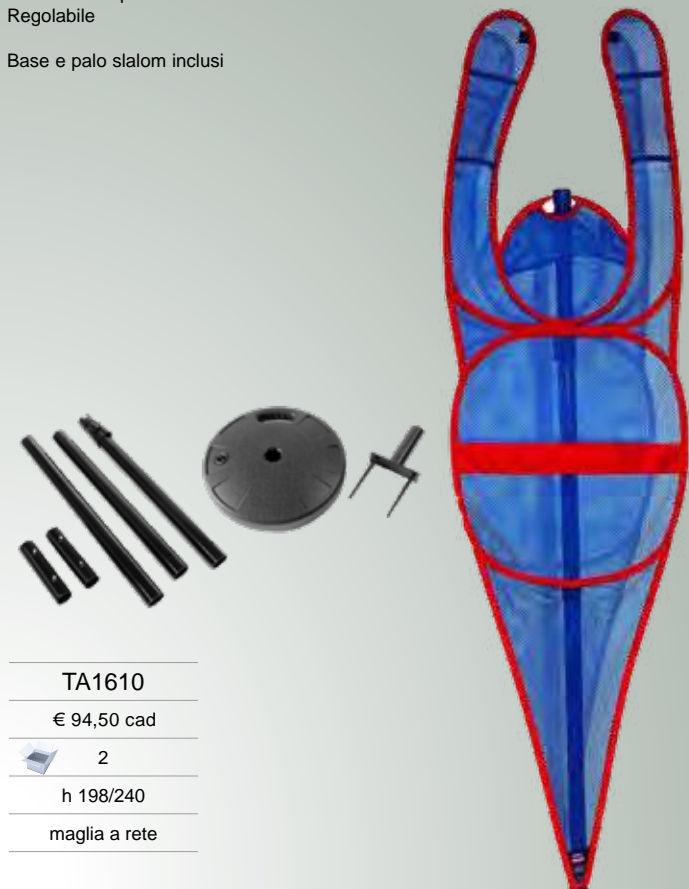

TA1610

€ 94,50 cad

2

h 198/240

maglia a rete

**CANESTRO MULTIPLAY**

Trasportabile su due ruote

Asta in alluminio nervata

Altezza regolabile fino a 305 cm

Tabellone cm 109x70

Canestro di colore nero completo di retina



05696M

€ 672,00 cad

1

ferro verniciato

**CANESTRO TRASPORTABILE**

Trasportabile su due ruote

Zavorra da 30 kg

Tabellone 60x90

Regolabile in altezza

da 200 a 260 cm



005696

€ 432,00 cad

1

ferro zincato

**IMP. BASKET TRASPORTABILE**

Impianto basket ideale per la pratica della pallacanestro sia all'interno che all'esterno

Cerchio verniciato in acciaio ad altezza 2,60 mt

Base riempibile con sabbia per dare più stabilità e sicurezza

Altezza regolabile da 2,60 a 3,05 mt

Rete inclusa



BBG120

€ 240,00 cad

1

h 260/305

ferro verniciato

## TABELLONE BASKET

Semicircolare  
Serigrafato



000118

€ 78,69 cad

1

cm 110x73

polipropilene

## TABELLONE BASKET 180

In resina melaminica  
per esterno  
escluso telaio e fori  
per aggancio canestro



00116A

€ 306,56 cad

1

cm 180x105x1

resina melaminica

## ATTREZZO PER RITORNO PALLA BASKET

**new**



128930

€ 75,20 cad

1

cm 38x13

abs

## TABELLONE MINIBASKET 120

In resina melaminica  
per esterno  
escluso telaio e fori  
per aggancio canestro



00116C

€ 202,46 cad

1

cm 120x90x1

resina melaminica

## TABELLONE BASKET PLEXIGLASS

Trasparente  
Spessore 15 mm



005687

€ 690,00 cad

1

cm 180x105

plexiglass

## PROTEZIONE SOTTOCANESTRO

Per bordo inferiore del tabellone  
da incollare



206300

€ 352,00 coppia

1

cm 180x32

**CANESTRO RECLINABILE  
AGGANCIO RETE CON FILO**

Con anello in tondo pieno  
Sistema di aggancio rete  
mediante filo in acciaio su tubo  
Protezione antinfortunistica  
in gomma brevettata  
Attestato di conformità TUV EN 1270  
Rete esclusa



106OML

€ 310,88 cad



1

acciaio verniciato

**CANESTRO FERRO ZINCATO**

Ferro zincato a caldo  
Ultraresistente  
per esterno  
Rete esclusa



000105

€ 60,90 cad



1

ferro zincato

**CANESTRO RECLINABILE**

Con anello in tondo pieno  
Protezione antinfortunistica in gomma brevettata  
Attestato di conformità TUV EN 1270  
Rete esclusa



104OML

€ 280,81 cad



1

acciaio verniciato

**RETE BASKET ACCIAIO**

000122

€ 18,56 cad



1

acciaio zincato

**CANESTRO**

Rete esclusa



000102

€ 28,95 cad



1

acciaio verniciato

**RETE BASKET PRO**

00B050

€ 16,03 coppia



1

ø 6

nylon

**CANESTRO RINFORZATO**

Rete esclusa



000103

€ 46,17 cad



1

acciaio verniciato

## PALETTE GIUDICI BASKET KIT 7 PEZZI



005723

€ 96,00 kit

1

## PALETTE BASKET PER SECONDI - KIT

Serie di 6 palette numerate fronte e retro 5/10/15/20/24



05723S

€ 96,00 kit

1

## FRECCIA ELETTRONICA POSSESSO PALLA BASKET



100255

€ 457,80 cad

1

cm 56x23,5x9

## PALETTE FALLI BASKET KIT 9 PZ

Set composto da 5 palette numerate in nero + 2 palette numerate in rosso + 1 palette cambio + una palette stop



468500

€ 106,20 kit

1

cm 35x17

pvc

## FRECCIA POSSESSO PALLA BASKET

Manuale



0105F1

€ 57,60 cad

1

ferro verniciato

## TAVOLO GIUDICI BASKET

Tavolo per giudici basket  
Struttura in tubo di acciaio verniciato  
Piano in bilaminato



572500

€ 1.120,00 cad

1

254x72x76 h

acciaio verniciato

## INDICATORI ELETTRONICI 24 SECONDI BASKET

Composto da una centralina munita di tastiera e due pannelli visualizzatori  
Cifre alte 20 cm colore rosso visibili da 70 mt  
Gestione della regola dei 14 secondi  
Spia verde indicante il conteggio in corso  
Segnalatore acustico di fine tempo  
Possibilità di modificare i tempi di possesso palla e time-out con un valore da 1 a 99 secondi  
Cavi di collegamento display inclusi  
2 pezzi: 29,2x30,4x4,4  
1 pezzo: 20x8x12,5

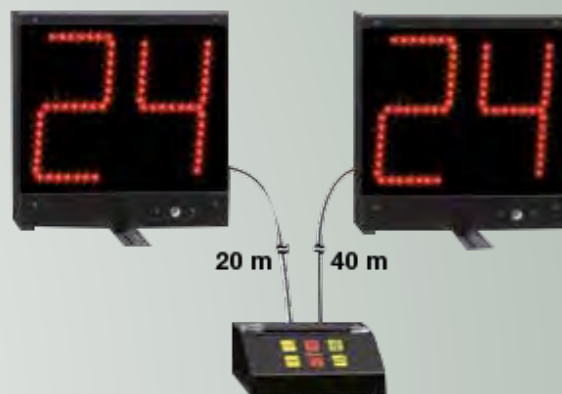

20 m 40 m

100270

€ 1.008,00 cad

1

**PALLONE HANDBALL GOLDEN ITALIA 3**

Consigliato dalla federazione F.I.G.H.  
per i campionati giovanili  
Gr 430

136500
€ 36,86 cad
 1
misura 3
pu

**PALLONE HANDBALL GOLDEN ITALIA 2**

Consigliato dalla federazione F.I.G.H.  
per i campionati giovanili  
Gr 340

136510
€ 36,86 cad
 1
misura 2
pu

**PALLONE HANDBALL GOLDEN ITALIA 1**

Consigliato dalla federazione F.I.G.H.  
per i campionati giovanili  
Gr 310

136520
€ 36,86 cad
 1
misura 1
pu



## PALLONE HANDBALL V49

Con valvola rigonfiabile  
Approvati FIGH  
Gr 420  
ø 17

Maschile



100070

€ 16,32 cad

1

misura 3

gomma doppio strato

## PALLONE HANDBALL SOFT BA29

Con valvola rigonfiabile  
Adatto per principianti  
Approvati FIGH  
Gr 200  
ø 16 cm

Junior



100094

€ 22,72 cad

1

misura 1

gomma soft

## PALLONE HANDBALL V30

Con valvola rigonfiabile  
Approvati FIGH  
Gr 320  
ø 16

Femminile



100092

€ 13,12 cad

1

misura 2

gomma doppio strato

## PALLONE MINIHANDBALL SOFT BA25

Con valvola rigonfiabile  
Gr 150  
ø 15 cm  
Per primo handball

Junior



100095

€ 22,40 cad

1

misura 1

gomma soft

## PALLONE HANDBALL V29

Con valvola rigonfiabile  
Approvati FIGH  
Gr 250  
ø 15

Junior



100091

€ 11,84 cad

1

misura 1

gomma doppio strato

## PALLONE MINIHANDBALL SOFT BA0

Con valvola rigonfiabile  
Approvato FIGH  
Gr 160  
ø 14 cm  
Pallone per mini minihandball

Bambini



100093

€ 22,08 cad

1

misura 0

gomma soft

## PALLONE HANDBALL ULT30

Pallone in gomma morbida triplo strato  
Ideale per scuole e mini-handball



100089

€ 23,04 cad

1

misura 2

gomma doppio strato

## PALLONE MICROHANDBALL SH1

Pallone ideale per Micro e Midi handball  
ø 14,5 cm



180700

€ 19,20 cad

1

200 gr

**PORTA HANDBALL PLASTICA**

Porta da handball in pvc  
 ø pali mm 70  
 Facile da montare grazie al metodo clicksystem  
 Trasportabile  
 Resiste alle intemperie

Rete, clip di fissaggio  
 e ancoraggi compresi

---

 HG0090
 

---

 € 234,00 cad
 

---

 1
 

---

 300x200
 

---

 pvc
 

---

**PORTE HANDBALL 3X2**

In acciaio verniciato  
 bianco/rosso tubo quadro  
 Smontabili e trasportabili  
 Sostegni posteriori  
 Alto cm 80 - basso cm 100  
 Trasportabili

Reti escluse

---

 007800
 

---

 € 1.080,00 coppia
 

---

 1
 

---

 cm 300x200
 

---

 acciaio
 

---

**PORTE HANDBALL 3X2**

In alluminio verniciato bian-  
 co/rosso tubo quadro  
 Smontabili e trasportabili  
 Sostegni posteriori  
 Alto cm 80 - basso cm 100  
 Trasportabili

Reti escluse

---

 007801
 

---

 € 1.410,00 coppia
 

---

 1
 

---

 cm 300x200
 

---

 lega
 

---



## RETE CALCETTO-HANDBALL 3x2

Maglia quadra  
annodata  
mm 100



Ø 3,5 mm

000159
€ 101,41 coppia
1
cm 300x200
pe

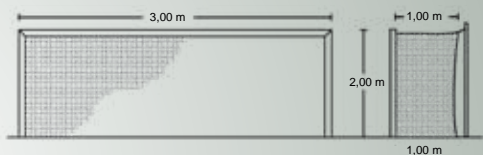

## LAVAGNA HANDBALL GRANDE

Lavagna handball magnetica e cancellabile  
Ideale per stabilire la strategia di gioco prima della partita

Pedine comprese  
Pennarello incluso

HA0010
€ 67,50 cad
1
cm 90x60



## RETE CALCETTO-HANDBALL 3x2

Maglia esagonale mm 120



Ø 4 mm

000150
€ 105,50 coppia
1
cm 300x200
ppht

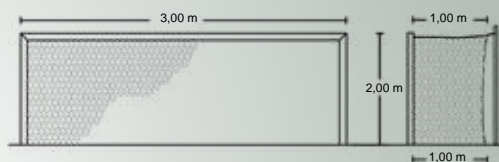

## LAVAGNA HANDBALL PICCOLA

Senza pedine  
Cancellabile

Pennarello incluso

HA0020
€ 14,40 cad
1
cm 23x34



## PECE TRIMONA 500



107001
€ 33,38 cad
1
500 gr

## LAVAGNA HANDBALL PICCOLA MAGNETICA

Lavagna per pallamano/calciotto  
Pedine e pennarello inclusi



46920H
€ 27,80 cad
1
cm 21,5x28,5
pvc

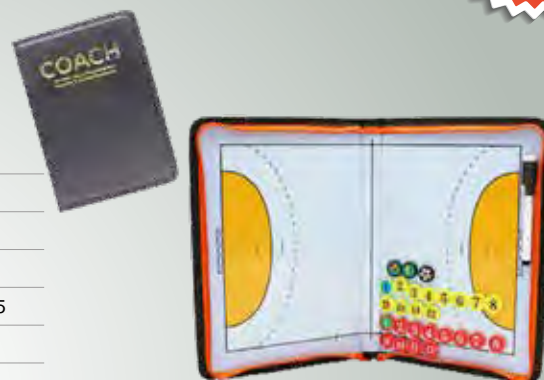

## LAVAGNA HANDBALL PICCOLA REVERSIBILE

Lavagna per pallamano/calciotto  
Pedine e pennarello inclusi



24373H
€ 14,85 cad
1
cm 22,9x34,2
pvc





CLAVETTE IN NYLON

Gr 154

- 04 Rosso
- 02 Giallo
- 08 Royal
- 06 Verde



180510

€ 11,07 coppia



1

cm 44

nylon

NASTRO RITMICA

Con bastoncino  
Colori assortiti

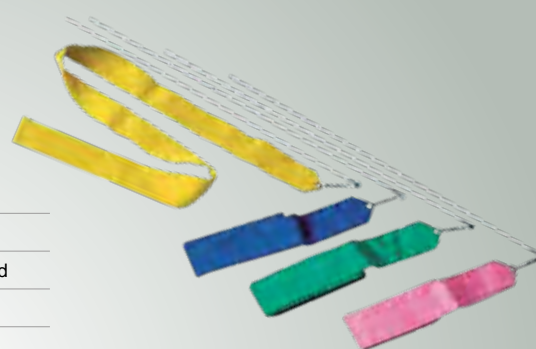

099001

€ 16,80 cad



1

mt 6

PALLA RITMICA PR42

Con valvola rigonfiabile  
Indicata nell'esercizio  
terapeutico e rieducativo  
Ø 19 cm

- 02 Giallo
- 04 Rosso
- 06 Verde
- 08 Royal



100101

€ 16,32 cad

1

gr 420

gomma sintetica

CORDA RITMICA

- 06 Verde
- 02 Giallo
- 04 Rosso
- 08 Royal



000CS5

€ 4,74 cad



1

mt 3

pp

PALLA RITMICA PR46

Con valvola rigonfiabile  
Indicat nell'esercizio  
terapeutico e rieducativo  
Ø 15 cm

- 02 Giallo
- 04 Rosso
- 06 Verde
- 08 Royal



100102

€ 13,76 cad

1

gr 240

gomma sintetica

BASTONE GINNASTICA



102010

€ 3,68 cad



1

cm 100 Ø 24

legno verniciato

## CERCHIO TUBOLARE 60

A sezione rotonda

02 Giallo



101260

€ 8,35 cad



1

ø 60

pe

## CERCHIO TUBOLARE 70

A sezione rotonda

04 Rosso



101270

€ 9,12 cad



1

ø 70

pe

## CERCHIO TUBOLARE 80

A sezione rotonda

06 Verde



101280

€ 10,50 cad



1

ø 80

pe

## CERCHIO TUBOLARE 90

A sezione rotonda

08 Royal



101290

€ 11,71 cad



1

ø 90

pe

## PEDANA CON MOLLE

Pedana elastica molleggiata in legno lamellare verniciato  
Con molle in acciaio  
Piano ricoperto in gomma

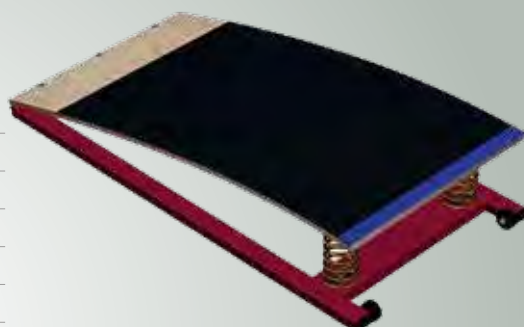

113300

€ 592,00 cad



1

legno lamellare

## MATERASSO GYM MAT

Materasso cellula chiusa



100873

€ 167,42 cad



1

cm 200x100x3 h

100874

€ 201,70 cad



1

cm 200x100x4 h

100875

€ 283,42 cad



1

cm 200x100x5 h

100876

€ 320,32 cad



1

cm 200x100x6 h

**BLOCCO DI PARTENZA NEO**

Blocco di partenza da competizione  
Regolabili in altezza e profondità  
Trattamento anti-corrosione  
Certificato IAAF



ASB001

€ 220,80 cad



1

alluminio estruso

**BLOCCO DI PARTENZA CHALLENGER**

Blocco di partenza da allenamento  
Regolabili in 4 diverse angolazioni  
Utilizzabili su tutte le superfici  
Trattamento anti-corrosione

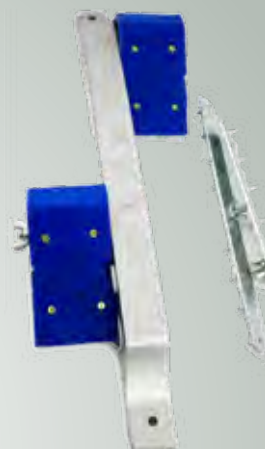

ASB002

€ 98,10 cad



1

misure

acciaio zincato

**OSTACOLO ATLETICA REGOLABILE H 50**

Ostacolo regolabile in 3  
altezze  
Con assicella in legno

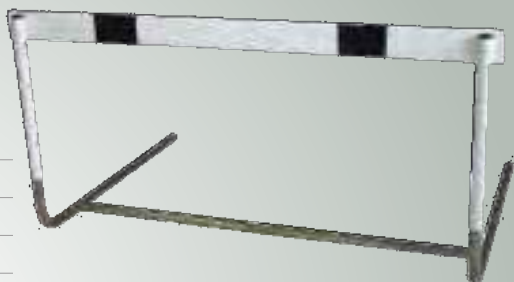

180601

€ 87,97 cad



1

h 50, 60, 76

acciaio zincato

**TESTIMONI ALLUMINIO 6 COLORI KIT 6 PZ**

Adatti per l'allenamento e la competizione  
6 colori diversi  
Certificato IAAF



AB0010

€ 36,00 kit



1

ø 3,80

alluminio anodizzato

**OSTACOLO ATLETICA REGOLABILE H 76**

Ostacolo regolabile in 3  
altezze  
Con assicella in legno



180602

€ 90,37 cad



1

h 76, 84, 91, 106

acciaio zincato

**TESTIMONI PVC 6 COLORI KIT 6 PZ**

Adatti per l'allenamento e la competizione  
6 colori diversi  
Certificato IAAF



AB0020

€ 16,20 kit



1

ø 3,80

pvc abs

## GIAVELLOTTO FOAM

Studiato per la propedeutica del lancio  
Le alette posteriori assicurano una perfetta stabilità nell'aria e rendono la sua traiettoria perfettamente lineare  
Grazie al tipo di materiale, assorbe tutti gli urti delle cadute



981400
€ 19,75 cad
1
cm 91
pte

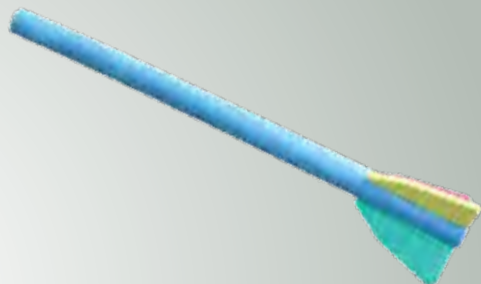

## ROTELLA METRICA 50

Rotella metrica in fibra  
Con impugnatura



019102
€ 31,78 cad
1
mt 50



## VORTEX GIAVELLOTTO

Per uso scolastico



113001
€ 33,80 cad
1
cm 32 - gr 130



## ROTELLA METRICA MT 20

Rotella metrica metri 20  
In fibra di vetro



120010
€ 15,80 cad
1
pvc



## CARRELLO PER TRASPORTO MATERASSI (T)

Carrello per trasporto materassi in tubo di acciaio verniciato con ruote gommatae

128000
€ 352,00 cad
1
200x100
acciaio verniciato



## CONTAMETRI

Con luce  
Può contare fino a 9999 mt

019758
€ 91,21 cad
1



## ASTICELLA SEGNALIMITE POLIETILENE

Asticella segnalimite in polietilene espanso  
Composta da 12 cilindri di lunghezza cm 33 ø 3  
Collegati da un elastico con alle estremità Farfalle per il bloccaggio

181000
€ 52,20 cad
1
misure
polietilene espanso



## NASTRO IN POLIETILENE

Per delimitare i percorsi

031501
€ 7,20 cad
1
mt 200
pe



**PALLA GETTO VDL10 KG 1**

Palla ideale per la propedeutica  
Ideale da utilizzare sia in interno che in esterno  
Non tossica e latex-free  
ø cm 10

103125

€ 52,80 cad

1

kg 1

gomma

**PALLA LANCIO GOMMA MORBIDA GR 80**

Palla in gomma sintetica reticolata  
Non rimbalza  
Atossica  
Propedeutica al lancio del peso

VT0800

€ 9,92 cad

1

gr 80

gomma morbida

**PALLA GETTO VDL 20 KG 2**

Palla ideale per la propedeutica  
Ideale da utilizzare sia in interno che in esterno  
Non tossica e latex-free  
ø cm 20

103126

€ 65,28 cad

1

kg 2

gomma

**PALLA LANCIO GOMMA MORBIDA GR 300**

Palla in gomma sintetica reticolata  
Non rimbalza  
Atossica  
Propedeutica al lancio del peso

VT3000

€ 18,24 cad

1

gr 300

gomma morbida

**PALLA GETTO VDL 30 KG 3**

Palla ideale per la propedeutica  
Ideale da utilizzare sia in interno che in esterno  
Non tossica e latex-free  
ø cm 30

103127

€ 82,56 cad

1

kg 3

gomma

**PALLA LANCIO GOMMA MORBIDA GR 500**

Palla in gomma sintetica reticolata  
Non rimbalza  
Atossica  
Propedeutica al lancio del peso

VT5000

€ 21,12 cad

1

gr 500

gomma morbida

**PALLA GETTO VDL 40 KG 4**

Palla ideale per la propedeutica  
Ideale da utilizzare sia in interno che in esterno  
Non tossica e latex-free  
ø cm 40

103128

€ 96,00 cad

1

kg 4

gomma

**PALLA LANCIO GOMMA MORBIDA GR 700**

Palla in gomma sintetica reticolata  
Non rimbalza  
Atossica  
Propedeutica al lancio del peso

VT7000

€ 26,24 cad

1

gr 700

gomma morbida



## DISCO GOMMA 3 IMPUGNATURE GR 600

Disco a 3 impugnature per la propedeutica al lancio  
 Presa 1: avviamento al lancio  
 Presa 2: allenamento  
 Presa 3: presa da gara  
 ø cm 20



181406
€ 50,88 cad
1
gr 600
gomma

## DISCO LANCIO KG 2

Disco da lancio regolamentare in nylon con bordo in acciaio  
 Tarato con tappo a vite a norme IAAF



346300
€ 51,20 cad
1
kg 2
nylon / acciaio

## DISCO GOMMA 3 IMPUGNATURE GR 400

Disco a 3 impugnature per la propedeutica al lancio  
 Presa 1: avviamento al lancio  
 Presa 2: allenamento  
 Presa 3: presa da gara  
 ø cm 20



181404
€ 32,32 cad
1
gr 400
gomma

## DISCO LANCIO KG 1.75

Disco da lancio regolamentare in nylon con bordo in acciaio  
 Tarato con tappo a vite a norme IAAF



346200
€ 48,00 cad
1
kg 1,75
nylon / acciaio

## DISCO GOMMA DSK KG 1

Disco in gomma reticolata super soffice  
 Utilizzabili per l'avviamento al lancio  
 Utilizzabili anche indoor

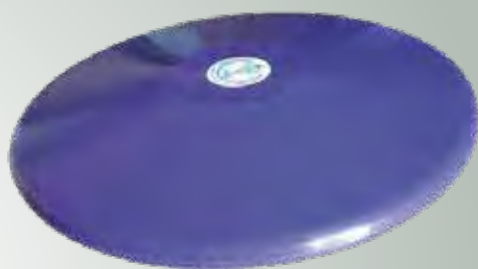

181510
€ 40,64 cad
1
kg 1
gomma soffiata

## DISCO LANCIO KG 1.5

Disco da lancio regolamentare in nylon con bordo in acciaio  
 Tarato con tappo a vite a norme IAAF



346100
€ 46,40 cad
1
kg 1,5
nylon / acciaio

## DISCO GOMMA DSK GR 300

Disco in gomma reticolata super soffice  
 Utilizzabili per l'avviamento al lancio  
 Utilizzabili anche indoor



181503
€ 31,68 cad
1
gr 300
gomma soffiata

## DISCO LANCIO KG 1

Disco da lancio regolamentare in nylon con bordo in acciaio  
 Tarato con tappo a vite a norme IAAF

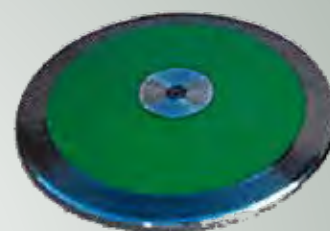













346000
€ 43,20 cad
1
kg 1
nylon / acciaio

## MATERASSI

In gommapiuma rivestito in pvc  
Antibatterico, antimuffa, ignifugo cl.2

Per materassi con fodera antiscivolo prezzo a preventivo



200100	200200	200300	200400	200500	200600
€ 192,00	€ 227,20	€ 273,00	€ 336,00	€ 406,00	€ 460,60
 1	 1	 1	 1	 1	 1
cm 200x100x5 h	cm 200x100x10 h	cm 200x100x20 h	cm 200x100x30 h	cm 200x100x40 h	cm 200x100x50 h
D/25	D/21	D/16	D/16	D/16	D/16
200800	200900	201000	201100	201200	201300
€ 770,00	€ 835,80	€ 921,20	€ 942,20	€ 1'152,20	€ 1'338,40
 1	 1	 1	 1	 1	 1
cm 200x200x40 h	cm 200x200x45 h	cm 200x200x50 h	cm 300x200x30 h	cm 300x200x40 h	cm 300x200x50 h
D/16	D/16	D/16	D/16	D/16	D/16

## MATERASSI

In gommapiuma rivestito in pvc  
Formato da 2 pezzi unibili fra loro  
Tagliati a 45° da un lato  
Antibatterico, antimuffa, ignifugo cl.2

Per materassi con fodera antiscivolo prezzo a preventivo









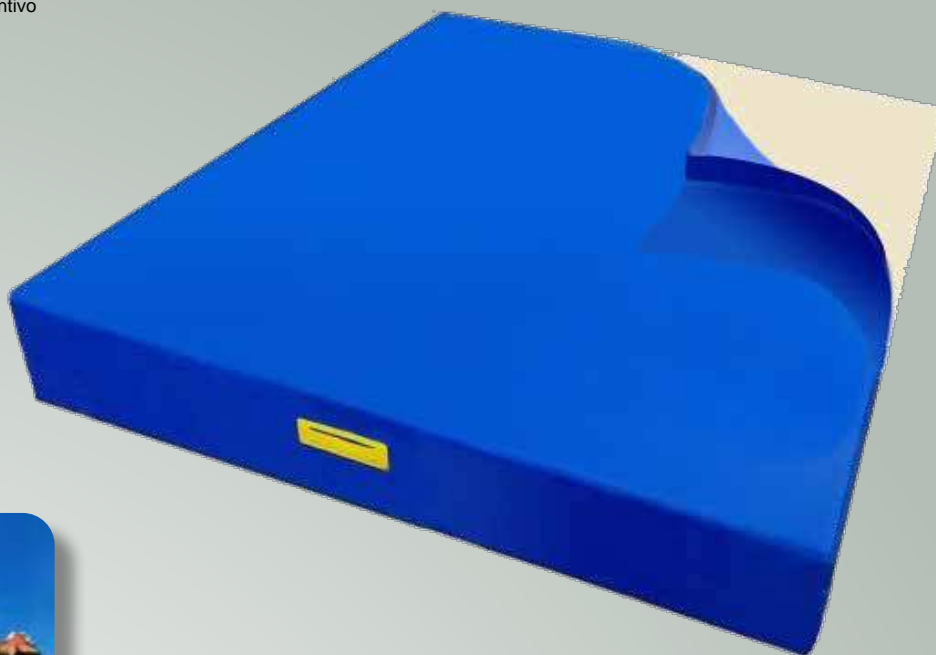





201400	201500	201600
€ 1.725,00 cad	€ 1.875,00 cad	€ 2.002,50 cad
 1	 1	 1
cm 400x200x40 h	cm 400x200x45 h	cm 400x200x50 h
T/45° - D/16	T/45° - D/16	T/45° - D/16

## FODERE

Per fodere antiscivolo prezzo a preventivo  
Antibatterico, antimuffa, ignifugo cl.2



203300	203400	203500	203600	203700	203800
€ 112,50 cad	€ 123,00 cad	€ 150,00 cad	€ 162,00 cad	€ 169,50 cad	€ 177,00 cad
 1	 1	 1	 1	 1	 1
cm 200x100x5 h	cm 200x100x10 h	cm 200x100x20 h	cm 200x100x30 h	cm 200x100x40 h	cm 200x100x50 h
pvc	pvc	pvc	pvc	pvc	pvc
203900	204000	204100	204200	204300	204400
€ 316,50 cad	€ 324,00 cad	€ 330,00 cad	€ 487,50 cad	€ 435,00 cad	€ 450,00 cad
 1	 1	 1	 1	 1	 1
cm 200x200x40 h	cm 200x200x45 h	cm 200x200x50 h	cm 300x200x30 h	cm 300x200x40 h	cm 300x200x50 h
pvc	pvc	pvc	pvc	pvc	pvc

## FODERE

Per fodere antiscivolo prezzo a preventivo  
Antibatterico, antimuffa, ignifugo cl.2  
Fodera in pvc

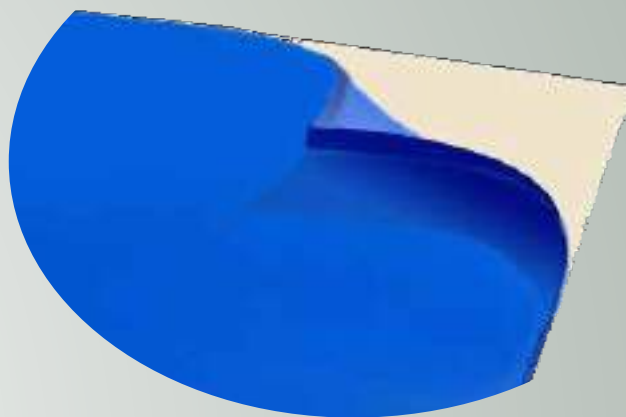

204500	204600	204700
€ 660,00 cad	€ 675,00 cad	€ 690,00 cad
 1	 1	 1
cm 400x200x40 h	cm 400x200x45 h	cm 400x200x50 h
T/45°	T/45°	T/45°



RACCHETTA BADMINTON VICTOR

034417  
 € 23,07 cad  
 1  
 cm 67  
 grafite - alluminio



RACCHETTA BADMINTON SIREN

034327  
 € 10,59 cad  
 1  
 cm 66  
 acciaio - alluminio



VOLANI NYLON III GARA

Punta in sughero e corpo in nylon  
 Da competizione  
 Velocità media  
 Kit 6 pezzi



241590  
 € 11,34 kit  
 1  
 ny / sughero



VOLANI PIUMA KIT 6 PZ

Punta in sughero

020260  
 € 8,60 kit  
 1  
 piuma / sughero



VOLANI NYLON 0.5 ALLENAMENTO

Punta in sughero e corpo in nylon  
 Da allenamento  
 Velocità media  
 Kit 6 pezzi



243820  
 € 10,44 kit  
 1  
 ny / sughero



VOLANI PLASTICA KIT 6 PZ

144911  
 € 12,48 kit  
 1  
 plastica



## IMPIANTO TRASPORTABILE MULTISPORT

Il set include 3 diverse reti: 1 calcio, 1 badminton e 1 volley + 2 tubi estensibili  
 La scatola funge da ancoraggio per i tubi  
 Rete tennis: 2,45x1,05 m  
 Rete badminton: 3,2x1,5 m  
 Rete volley: 3,02x2,24 m



641700

€ 132,84 kit



1

pc

## IMPIANTO MINIVOLLEY - BADMINTON

Impianto trasportabile su ruote  
 Zavorrato



006780

€ 464,00 cad



1

ferro verniciato

## IMPIANTO BADMINTON 300



BN0040

€ 102,60 cad



1

cm 300x170 h

alluminio

## RETE BADMINTON REGOLAMENTARE

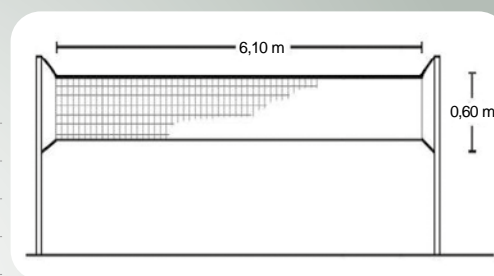

00P160

€ 49,18 cad



1

cm 610x60 h

pe

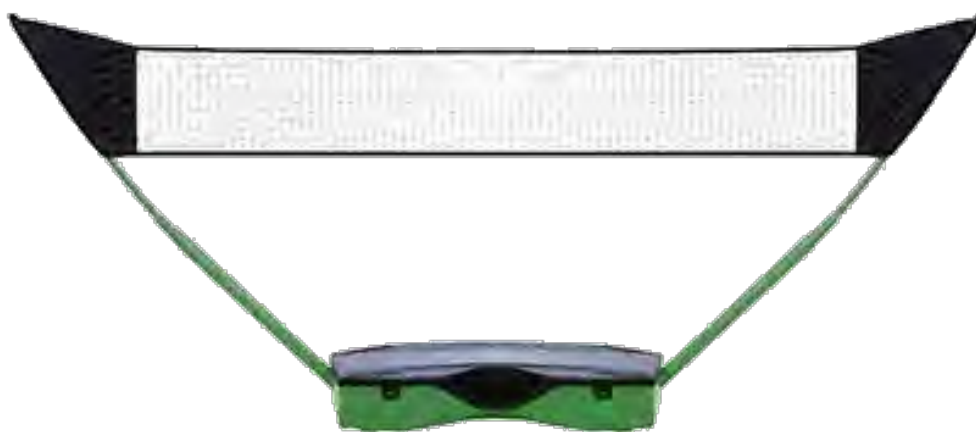

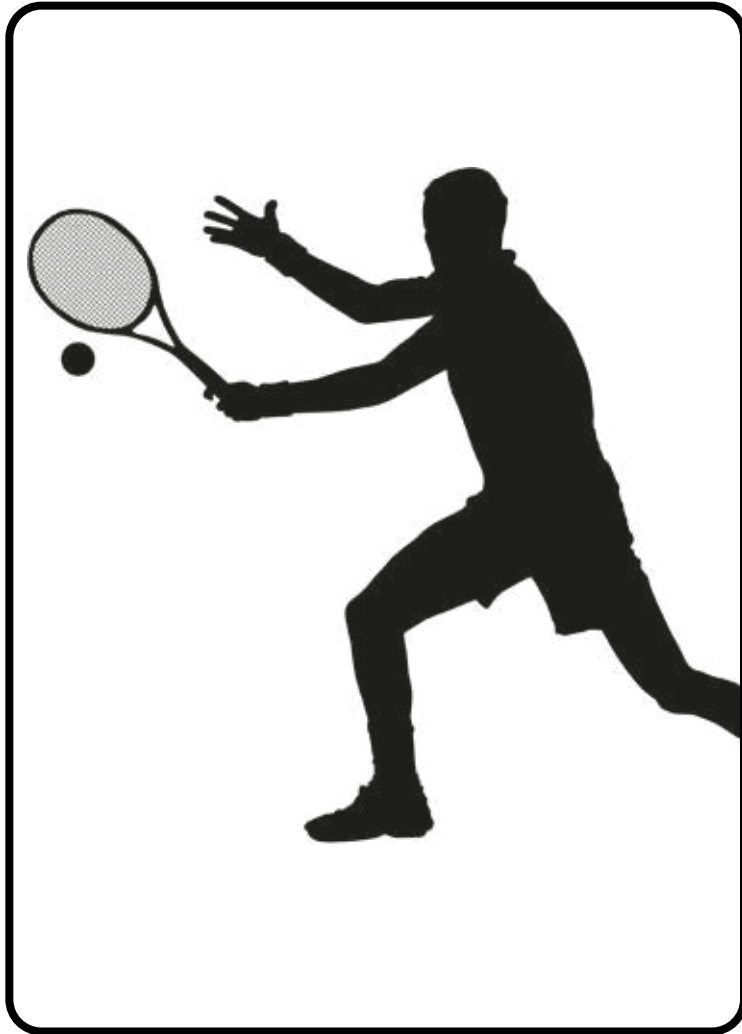

## PALLINE SOFT TENNIS

Indicato per attività didattica  
Kit composto da 3 palline

014861

€ 2,34 kit

1

Ø 7 cm

spugna



## CESTO PER PALLINE TENNIS

palline non incluse

TE0100

€ 54,00 cad

1

cm 27x27x84 h

ferro



## NASTRO SEGNACAMPO TENNIS

T00300

€ 237,44 cad

1

mt 150x5 h

pvc

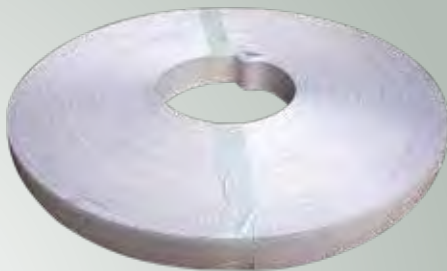

## NASTRO CENTRORETE TENNIS

Misura regolamentare con gancio

T00100

€ 18,66 cad

1



## PULISCI SCARPE

TR005U

€ 64,80 cad

1

cm 27x35

plastica

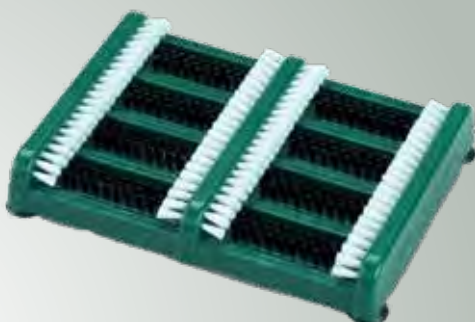

## RETE TENNIS

Maglia mm 45  
Ø mm 4  
Cavo d'acciaio ricoperto mm 5

T02200

€ 209,63 cad

1

mt 12,80x1

pp

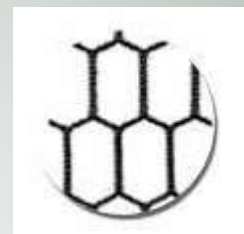

## PALI TENNIS ALLUMINIO

Pali tennis in tubo di alluminio ø mm 120  
Bossole da interrare  
Macchinetta tendirete

Rete esclusa

881900

€ 576,00 coppia

1

alluminio



## IMPIANTO TENNIS 600x90

Impianto tennis professionale  
Trasportabile  
In alluminio  
Con sacca per il trasporto

TE0060

€ 281,60 cad

1

cm 600x90 h

alluminio



## PALI TENNIS PER PALESTRA

Pali tennis in tubo di alluminio ø mm 120  
Macchinetta tendirete  
Da utilizzare esclusivamente in palestra  
Comprensivo di piastra per fissaggio  
a pavimento con attacchi a vite

Rete esclusa

88190T

€ 627,20 coppia

1

alluminio



## IMPIANTO MINI TENNIS

Sacca compresa

032304

€ 97,20 cad

1

cm 300x90 h

ferro verniciato

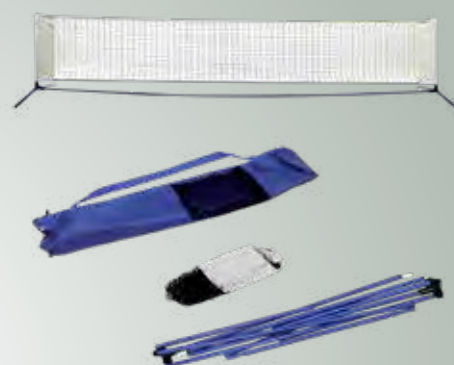

## PALI TENNIS ACCIAIO

Pali tennis in tubo di acciaio ø mm 120  
Bossole da interrare  
Macchinetta tendirete

Rete esclusa

882000

€ 352,00 coppia

1

acciaio



## SEDIA ARBITRO TENNIS

Sedia per arbitro tennis in alluminio  
Struttura portante in tubo quadro  
Scocca in plastica

88350A

€ 1.088,00 cad

1

alluminio



## RUOTA PER RACCOLTA PALLINE TENNIS

Ruota per raccogliere palline da tennis  
Facile e comoda da usare  
Manico estensibile  
Altezza minima 33,5 cm  
Altezza massima 110 cm  
Diametro ruota 27 cm

**new**

992620

€ 112,00 cad

1

cm 110x29

acciaio



## TUBO RACCOLTA PALLINE TENNIS

Tubo per raccogliere palline da tennis  
Può contenere fino a 15 palline

**new**

243410

€ 28,90 cad

1

cm 96x12

pe



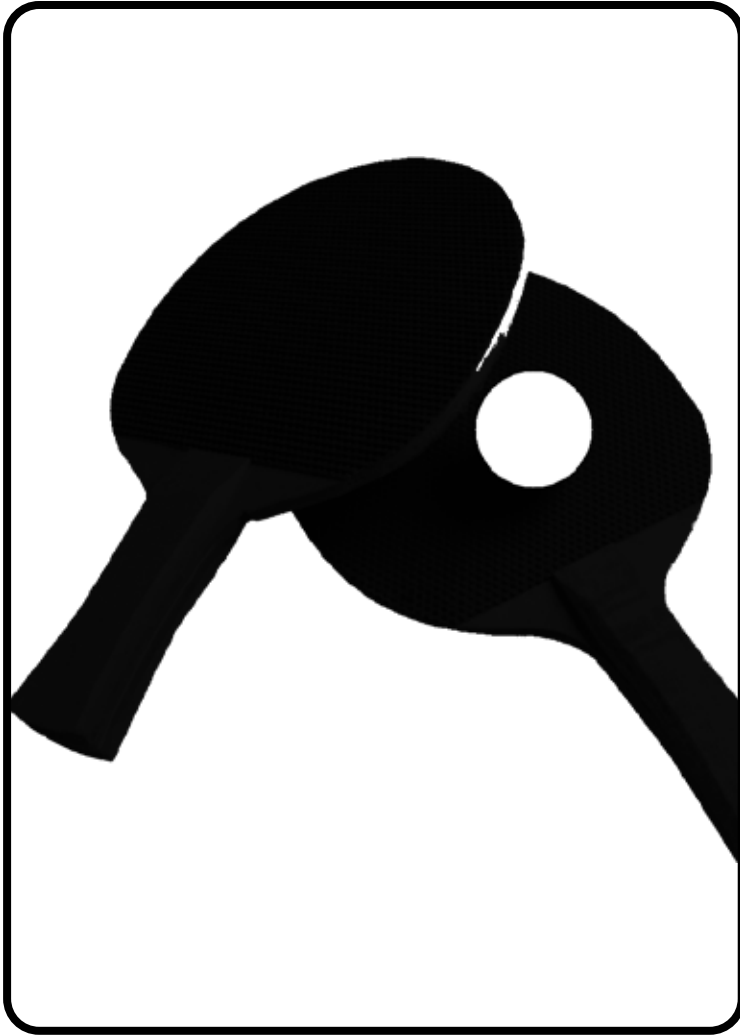

## RETE TENNIS TAVOLO

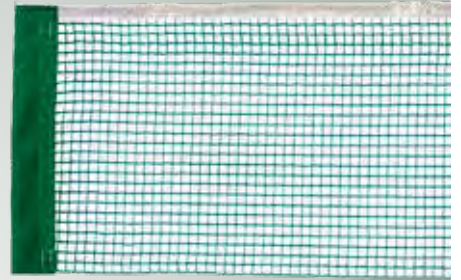

0TV015

€ 3,68 cad



1

## SUPPORTO CON PINZA RETE PING PONG

Kit composto da 2 supporti + 1 rete  
Supporti agganciabili tramite morsetto  
e regolabili

new



691200

€ 35,82 cad



1

cm 22x15 h

## PALLINE PING PONG KIT 60 PZ

Kit composto da 60 palline  
Diametro 40 mm  
Da competizione  
3 stelle

new



241610

€ 22,96 kit



1

mm 40

abs

## PALLINE PING PONG KIT 6 PZ

Kit composto da 6 palline  
Diametro 40 mm  
Da competizione

new



241600

€ 3,96 kit



1

mm 40

abs

## RACCHETTA TENNIS TAVOLO



182500

€ 10,24 cad



1



## BASTONE HOCKEY FLOORBALL



241920
€ 13,52 cad
1
cm 85
pvc

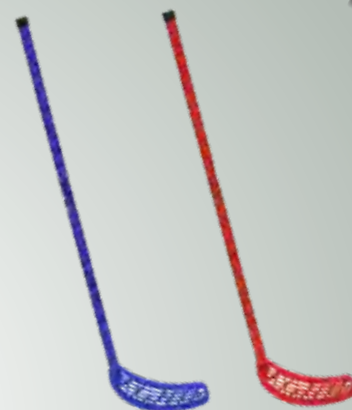

## PALLINA HOCKEY FLOORBALL 100

Pallina forata



244350
€ 2,88 cad
1
ø 100
pvc



## PORTICINA HOCKEY FLOORBALL

Smontabile  
 Profilo a sezione tonda mm 30  
 Rete inclusa



210801
€ 230,05 cad
1
cm 160x115 h
acciaio verniciato

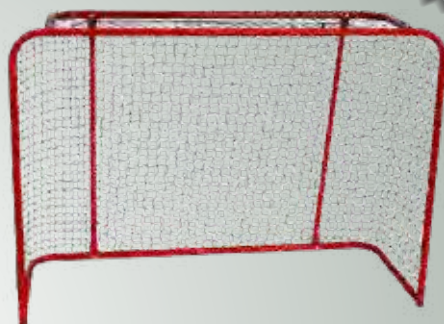

## PALLINA HOCKEY FLOORBALL 70

Pallina forata



244340
€ 2,20 cad
1
ø 70
pvc

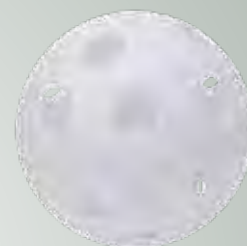

## DISCO HOCKEY FLOORBALL



111520
€ 2,24 cad
1
ø 75
pvc





### IMPIANTO BEACH VOLLEY/TENNIS

Impianto beach-volley con  
bossole da interrare  
Formato da 2 montanti in  
tubo di acciaio zincato

Rete esclusa

06797T

€ 448,00 cad

1

acciaio zincato



### RETE BEACH VOLLEY QUADRA

Maglia quadra mm 100  
Ø 3,5 mm  
Nastro in pvc doppio mm 75

P19000

€ 144,26 cad

1

cm 850x100 h

pp



### KIT SEGNALETICA CAMPO BEACH VOLLEY

Composto da 4 nastri in polipropilene  
h 5 cm  
8 picchetti  
8 elastici

000P17

€ 82,43 kit

1

mt 16x8



### PALLONE BEACH VOLLEY BV 2000

Indicato per il tempo libero  
Cucito a macchina  
Gr 260-280

Colori assortiti

137190

€ 13,76 cad

1

misura 5

pvc



## PORTE BEACH SOCCER

Porta beach-soccer in lega leggera a sezione rotonda  
Con bossola a croce mm80  
Traversa divisa



4644BS

€ 1.614,00 coppia

1

mt 5,50x2,20 h

lega leggera

## RETE PROTEZIONE CAMPI MM 100

Prezzo al metro quadro  
con corda perimetrale  
Larghezza quadro rete  
mm 100  
Diametro mm 3



430100

€ 3,04 mq



misure a richiesta

pe

## RETE BEACH SOCCER

Maglia esagonale mm120



Ø 4 mm

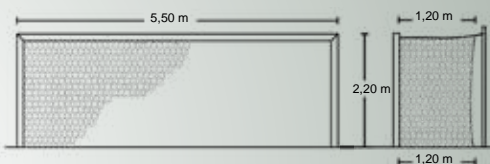

00P220

€ 156,70 coppia

1

cm 550x220

ppht

## RETE PROTEZIONE CAMPI MM 140

Prezzo al metro quadro  
con bordatura perimetrale  
Larghezza quadro rete  
mm 140  
Diametro mm 3



460140

€ 2,50 mq



misure a richiesta

pe

## KIT SEGNALETICA CAMPO BEACH SOCCER

Composto da:  
2 nastri da 37 mt  
2 nastri da 28 mt  
8 picchetti  
8 elastici



00P221

€ 192,32 kit

1

pl

## RETE PROTEZIONE CAMPI MM 45

Prezzo al metro quadro  
con bordatura perimetrale  
Larghezza quadro rete  
mm 45  
Diametro mm 3

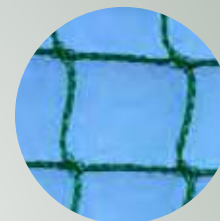

440045

€ 5,22 mq



misure a richiesta

pe

## PALLONE BEACH SOCCER COPACABANA



136150

€ 22,27 cad

1

misura 5

pvc



TRIBUNA TRASPORTABILE CON SEDUTE SCHIENALE

Panchetta su 3 file trasportabile su ruote  
 Struttura in acciaio zincato  
 Sedute in pvc con schienale  
 Piani di calpestio in carply



12006S

€ preventivo

 1

SEDUTA IGNIFUGA ANTI UV



M90000

€ 23,24 cad

 1

pp

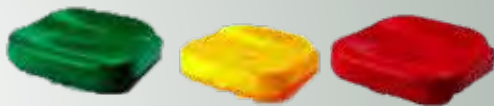

SEDUTA ANTI UV CON SCHIENALE



605803

€ 27,20 cad

 1

pp

TASSELLO SEDUTE PER FISSAGGIO

Tassello per fissaggio al cemento



390020

€ 1,60 cad

 1

## TRIBUNA TRASPORTABILE CON SEDUTE

Panchetta su 3 file trasportabile su ruote  
 Struttura in acciaio zincato  
 Sedute in pvc  
 Piani di calpestio in carply



120006

€ preventivo



1

## TRIBUNA TRASPORTABILE PANCA

Panchetta su 3 file trasportabile su ruote  
 Struttura in acciaio zincato  
 Piani di seduta e calpestio in carply

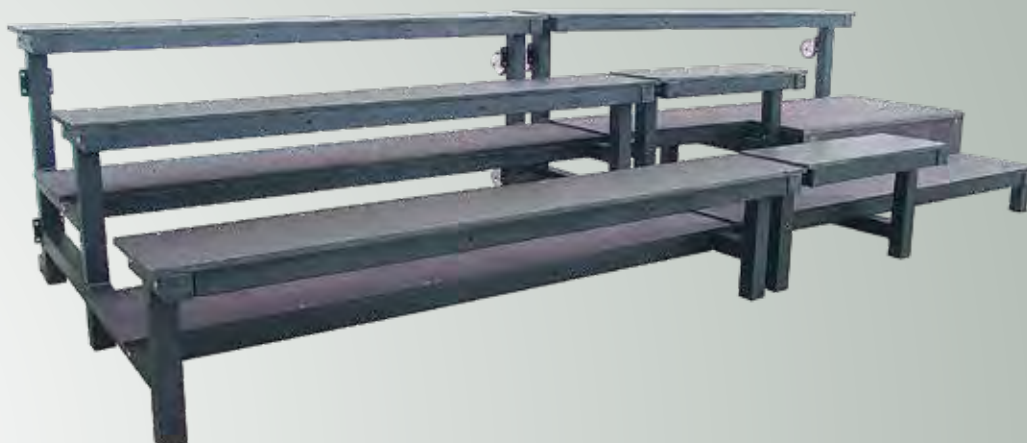

120005

€ preventivo



1

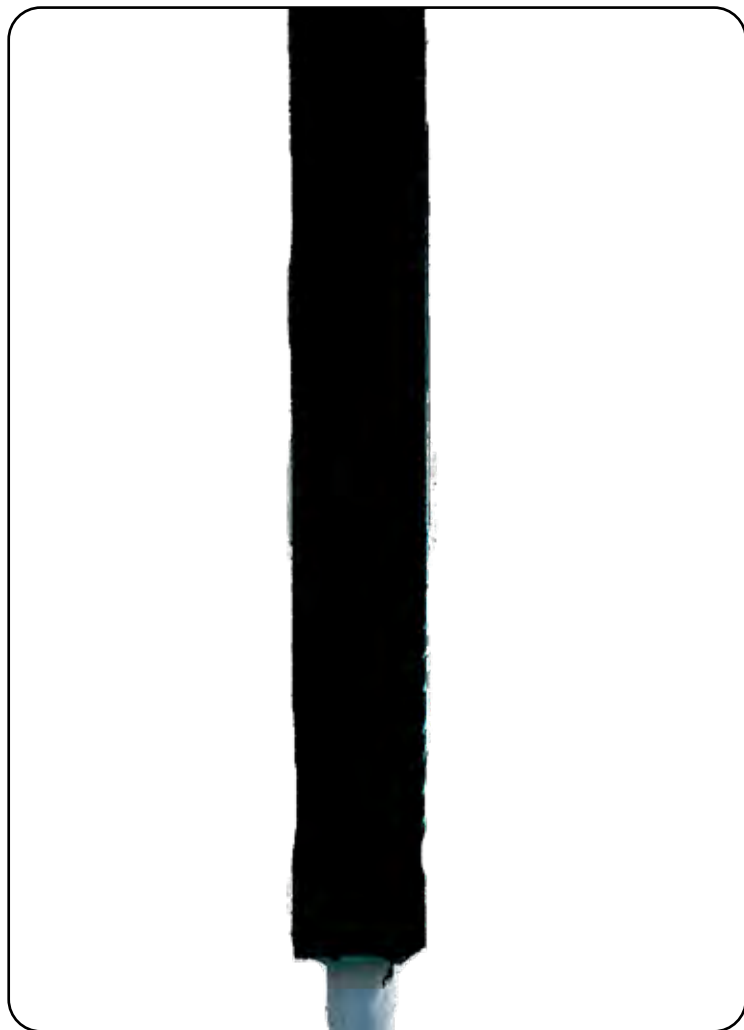

### PROTEZIONE CIRCOLARE F 20

Per esterno  
Per ricoprire pilastri tondi o pali luce  
Poliuretano espanso  
ricoperto da telo pvc antitaglio  
Chiusura con velcro  
Foro ø 20 cm  
Spessore 10 cm



032590

€ 329,64 cad



1

cm 200 h

poliuretano / pvc

### PROTEZIONE CIRCOLARE F 15

Per esterno  
Per ricoprire pilastri tondi o pali luce  
Poliuretano espanso  
ricoperto da telo pvc antitaglio  
Chiusura con velcro  
Foro ø 15 cm  
Spessore 10 cm



**new**

032586

€ 321,00 cad



1

cm 200 h

poliuretano / pvc

### PROTEZIONE CIRCOLARE F 2

Per esterno  
Per ricoprire pilastri tondi o pali luce  
Poliuretano espanso  
ricoperto da telo pvc antitaglio  
Chiusura con velcro  
Foro ø 2 cm  
Spessore 6 cm



**new**

032593

€ 110,49 cad



1

cm 200 h

poliuretano / pvc

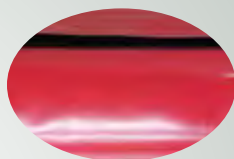

### PROTEZIONE CIRCOLARE F 10

Per esterno  
Per ricoprire pilastri tondi o pali luce  
Poliuretano espanso  
ricoperto da telo pvc antitaglio  
Chiusura con velcro  
Foro ø 10 cm  
Spessore 10 cm



**new**

032582

€ 291,24 cad



1

cm 200 h

poliuretano / pvc



### PROTEZIONE CIRCOLARE MIS. FUORI CATALOGO

Per esterno  
Per ricoprire pilastri tondi o pali luce  
Poliuretano espanso  
ricoperto da telo pvc antitaglio  
Chiusura con velcro



MACICA

€ preventivo



1

a richiesta

poliuretano / pvc

## PROTEZIONE MURALE CM 200x200 SP 10

Per esterno  
Ricoperto da telo pvc antitaglio  
Con occhielli  
Spessore 10



032526

€ 421,29 cad



1

cm 200x200x10h

poliuretano / pvc

## PROTEZIONE MURALE CM 200x100 SP 6

Per esterno  
Ricoperto da telo pvc antitaglio  
Con occhielli  
Spessore 6



032522

€ 189,75 cad



1

cm 200x100x6h

poliuretano / pvc

## PROTEZIONE MURALE CM 200x150 SP 10

Per esterno  
Ricoperto da telo pvc antitaglio  
Con occhielli  
Spessore 10



032525

€ 323,19 cad



1

cm 200x150x10h

poliuretano / pvc

## PROTEZIONE MURALE CM 150x100 SP 6

Per esterno  
Ricoperto da telo pvc antitaglio  
Con occhielli  
Spessore 6



032541

€ 162,99 cad



1

cm 150x100x6h

poliuretano / pvc

## PROTEZIONE MURALE CM 200x100 SP 10

Per esterno  
Ricoperto da telo pvc antitaglio  
Con occhielli  
Spessore 10



032524

€ 233,10 cad



1

cm 200x100x10h

poliuretano / pvc

## Colori disponibili per le protezioni



02



04



06



08

**Consegna 30 giorni**  
**Delivery time 30 days**

## PROTEZIONE MURALE MIS. FUORI CATALOGO

Poliuretano espanso ricoperto da telo pvc antitaglio



MATTCA

€ preventivo



1

a richiesta

poliuretano / pvc



## PROTEZIONE TUBOLARE CM 200

Protezione tubolare  
Gommapiuma rivestita in PVC  
Dimensione modulo cm 200  
Ø interno cm 5  
Spessore cm 5

Colori rosso, verde, blu



325150

€ 109,60 cad

1

cm 200

gommapiuma riv. pvc

## COLLA GR 850

Ideale per incollare lastre e profili espansi (no pvc) su varie superfici (legno, marmo, cemento, ceramica e metallo) sia da esterno che da interno



212000

€ 39,90 cad

1

gr 850

colla

## PROTEZIONE TUBOLARE CM 100

Protezione tubolare  
Gommapiuma rivestita in PVC  
Dimensione modulo cm 100  
Ø interno cm 5  
Spessore cm 5

04 Rosso  
08 Royal



325160

€ 72,45 cad

1

cm 100

gommapiuma riv pvc

## COLLA KG 4

Ideale per incollare lastre e profili espansi (no pvc) su varie superfici (legno, marmo, cemento, ceramica e metallo) sia da esterno che da interno



211900

€ 94,05 cad

1

kg 4

colla

## PROTEZIONE TUBOLARE CM 200

Protezione tubolare  
Gommapiuma rivestita in PVC  
Dimensione modulo cm 200  
Ø interno cm 5  
Spessore cm 5

04 Rosso  
08 Royal



325150

€ 107,94 cad

1

cm 200

gommapiuma riv pvc

## COLLA KG 9

Ideale per incollare lastre e profili espansi (no pvc) su varie superfici (legno, marmo, cemento, ceramica e metallo) sia da esterno che da interno



211800

€ 200,88 cad

1

kg 9

colla

## PROTEZIONE RIBALTINA KIT 12 PZ

Protezione tubolare per ribaltina alzarete  
Materiale espanso rivestito  
Dimensione modulo cm 200

Colore bianco



4580RP

€ 144,00 kit

1

cm 200x12 pz

espanso rivestito

**PER OGNI MQ SERVONO 300 GR DI COLLA**

**PER MQ SI INTENDE IL TOTALE SUPERFICIE + PROTEZIONE**

**UNA VOLTA STESA LA COLLA SULLE SUPERFICI, ASPETTARE 15 MINUTI PRIMA DI POSIZIONARE LA PROTEZIONE**

## PROTEZIONE ANGOLARE H 200

Ignifuga  
Sp 2,2

04 Rosso  
08 Royal

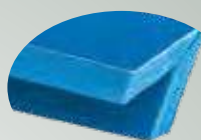

213300

€ 36,13 cad

1

cm 5x5x200 h

espanso riv pvc



## PROTEZIONE LASTRA

Sp 2,2  
Rivestita con pvc

04 Rosso  
08 Royal



211600

€ 221,61 cad

1

cm 200x130

pe2



## PROTEZIONE ANGOLARE H 130

Ignifuga  
Sp 2,2

04 Rosso  
08 Royal

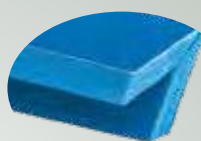

213200

€ 23,49 cad

1

cm 5x5x130 h

espanso riv pvc



## PROTEZIONE LASTRA FLEXI

Sp 2,2  
Rivestita con pvc

04 Rosso  
08 Royal



211700

€ 294,00 cad

1

cm 200x130

pe2

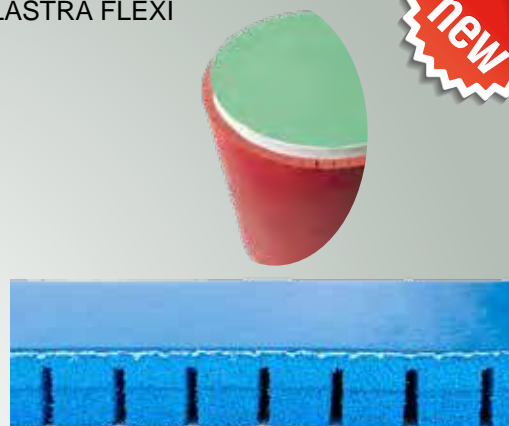

## GUAINA PROTEZIONE DIA 43

Rivestita da film antigraffio

04 Rosso  
08 Royal



213000

€ 50,88 cad

1

cm 235

pe3

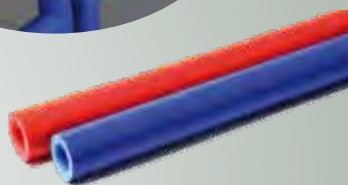

## GUAINA PROTEZIONE DIA 51

Spessore 5,1  
Rivestita da film antigraffio

04 Rosso  
08 Royal

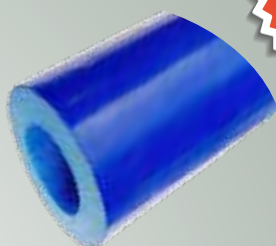

213100

€ 62,37 cad

1

cm 250

pe3

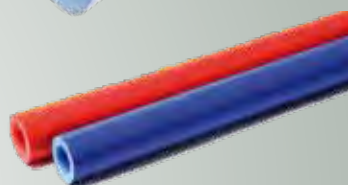

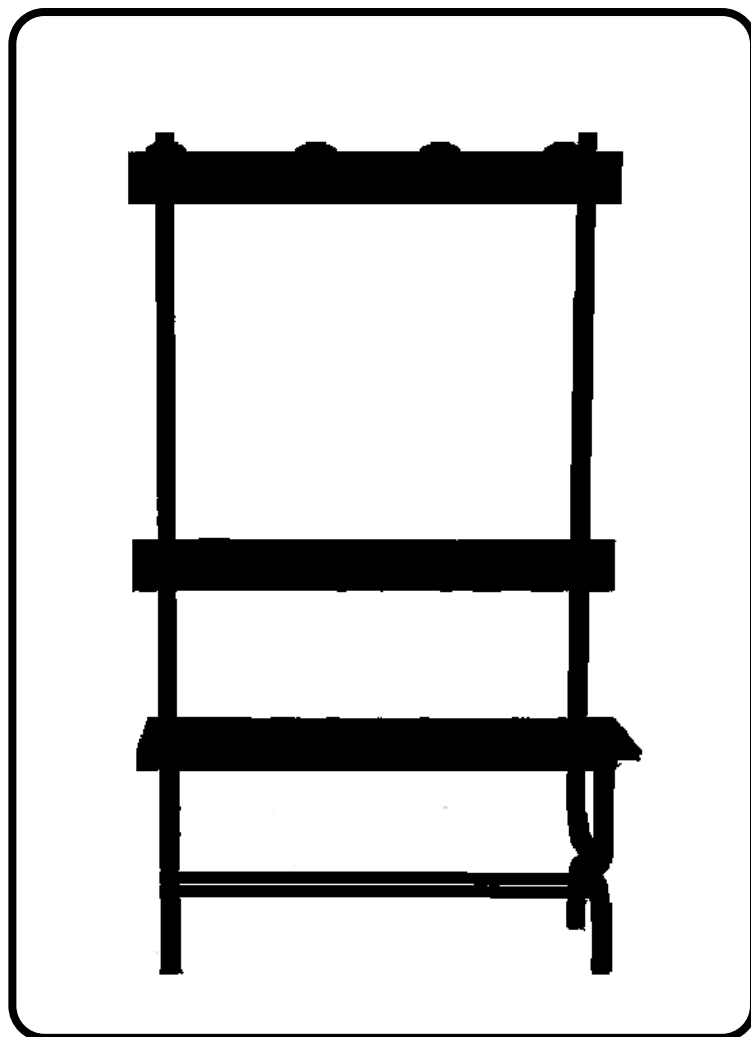

**ATTACCAPANNI CON PORTABORSE 2 MT**

Da fissare a parete da mt 2  
8 posti con soprastante portaborse  
in legno

10909E

€ 150,40 cad



1

mt 2

legno verniciato

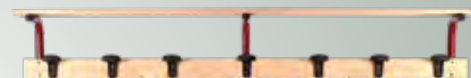

**ATTACCAPANNI CON PORTABORSE 1 MT**

Da fissare a parete da mt 1  
4 posti con soprastante portaborse  
in legno

10909I

€ 108,80 cad



1

mt 1

legno verniciato



**ATTACCAPANNI 2 MT**

Da fissare a parete da mt 2  
8 posti

10908E

€ 48,00 cad



1

mt 2

legno verniciato



**ATTACCAPANNI 1 MT**

Da fissare a parete mt 1  
4 posti

10908I

€ 32,00 cad



1

mt 1

legno verniciato



**PEDANA POGGIPIEDI 2 MT**

10912E

€ 112,00 cad



1

mt 2

legno verniciato



**PEDANA POGGIPIEDI 1 MT**

10912I

€ 67,20 cad



1

mt 1

legno verniciato



### PANCA SPOGLIATOIO SEMPLICE 2 MT



10900E
€ 220,80 cad
1
mt 2
legno verniciato

### PANCA SPOGLIATOIO SEMPLICE 1 MT



109001
€ 150,40 cad
1
mt 1
legno verniciato

### PANCA SPOGLIATOIO CON SCHIENALE 2 MT

Tubo di acciaio verniciato a sezione tonda da mm 35



10901E
€ 275,20 cad
1
mt 2
legno verniciato

### PANCA SPOGLIATOIO CON SCHIENALE 1 MT

Tubo di acciaio verniciato a sezione tonda da mm 35



109011
€ 198,40 cad
1
mt 1
legno verniciato

### PANCA SPOGLIATOIO 2 MT

Con schienale e appendiabiti  
Tubo di acciaio verniciato a sezione tonda dia mm 35



10902E
€ 358,40 cad
1
mt 2
legno verniciato

### PANCA SPOGLIATOIO 1 MT

Con schienale e appendiabiti  
Tubo di acciaio verniciato a sezione tonda dia mm 35



109021
€ 252,80 cad
1
mt 1
legno verniciato

### PANCA SPOGLIATOIO COMPLETA 2 MT

Tubo di acciaio verniciato a sezione tonda dia mm 35  
Sedili schienale e attaccapanni  
Soprastante portaborse di legno verniciato

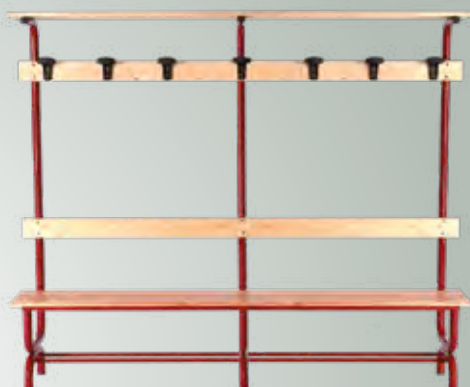

10903E
€ 432,00 cad
1
mt 2
legno verniciato

### PANCA SPOGLIATOIO COMPLETA 1 MT

Tubo di acciaio verniciato a sezione tonda dia mm 35  
Sedili schienale e attaccapanni  
Soprastante portaborse di legno verniciato



109031
€ 320,00 cad
1
mt 1
legno verniciato

**MUD CLEANER PULISCI SCARPE**

Attrezzo pulisci scarpe calcio  
Completo di tubo in gomma da mt 3  
L'acqua fuoriesce direttamente sulle  
spazzole per una perfetta pulizia  
della scarpa

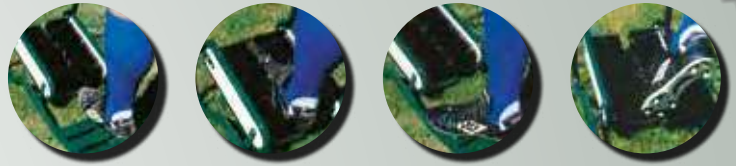

OUTLET  
solo per esaurimento scorte

191500
€ 260,90 cad
1
cm 79x35,5x94 h
ferro verniciato



**KIT SPAZZOLE MUD CLEANER**

Ricambio spazzole: 2 laterali + 1 base  
Spazzola base 28x11,5x6h  
Spazzola laterale 31,5x7,5x11h



OUTLET  
solo per esaurimento scorte

1AT010
€ 71,36 kit
1

**LAVASCARPE GREEN**

Supporto poggiamani smontabile  
2 spazzole inferiori e 2 spazzole laterali  
4 getti d'acqua incrociati con angolazione regolabile



new

200270
€ 223,41 cad
1
acciaio verniciato

**KIT SPAZZOLE BASE LAVASCARPE GREEN**

Kit 2 spazzole per base lavascarpe  
green

new

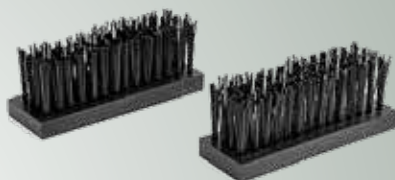

202701
€ 25,80 kit
1
cm 15x5
ny

**KIT SPAZZOLE LATO LAVASCARPE GREEN**

Kit 2 spazzole laterali per lavascarpe  
green

new

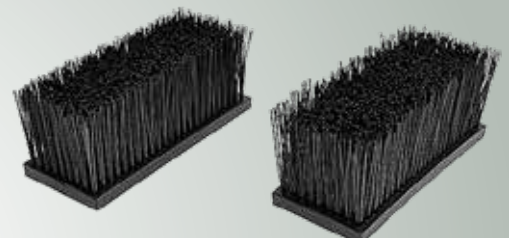

202702
€ 63,60 kit
1
cm 25x10
ny

### PAVIMENTAZIONE ACQUAFLOOR

Pavimentazione componibile  
antiscivolo in morbido pvc  
1 mq = 9 pezzi  
Trattamento antifungo e antibatterico  
Spessore mm 12  
Per piscine e spogliatoi

000099
€ 76,06 mq
1 mq
cm 32,5x32,5
pvc

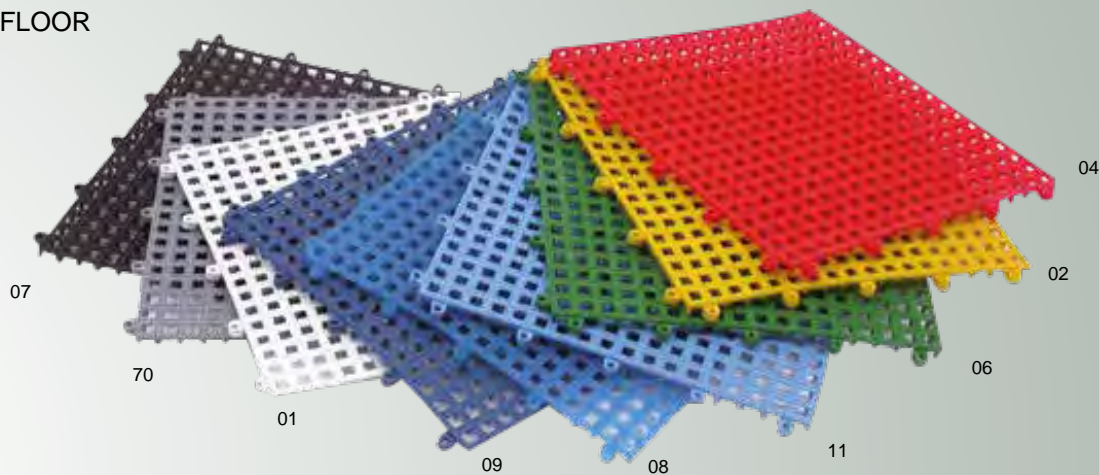

### ATTACCAPANNI A COLONNA



011943
€ 80,00 cad
1

### LETTINO VISITA MEDICA

In tubo di acciaio cromato  
Smontabile  
Testiera inclinabile  
Piano imbottito e rivestito  
in sky



011935
€ 540,40 cad
1
cm 185x56x75 h
acciaio cromato

### BILANCIA PROFESSIONALE

Con statimetro



ZT1200
€ 255,20 cad
1

### LETTINO MASSAGGI TRASPORTABILE

Letto portatile per massaggi  
Lunghezza 195 cm o 225 cm  
con poggiatesta  
Altezza regolabile da 61 a 80 cm  
Larghezza 70 cm o 92 cm  
con braccioli  
Peso massimo portata 300 kg  
Imbottitura in schiuma espansa  
Con borsa per il trasporto



180400
€ 409,60 cad
1
cm 195/225
alluminio

### ROTOLO CARTA COPRI LETTINO

Rotoli di carta "doppio velo"  
di ottima qualità  
Resistente e con facilità  
di strappo  
Da utilizzarsi come  
lenzuolino per lettino



407564
€ 9,60 cad
6
cm 60x80 mt
pura cellulosa

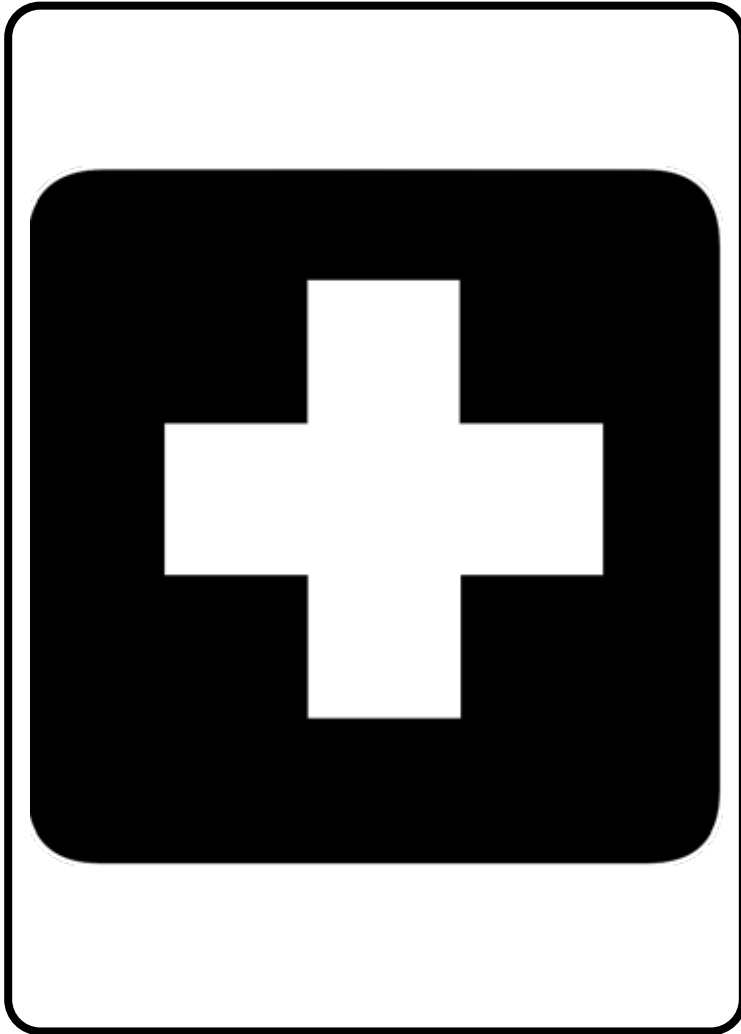

NASTRO TAPE STRAPPAL 2,5x14

172702  
 € 5,94 cad  
 36  
 cm 2,5x14 mt



NASTRO TAPE 3,8x10

550349  
 € 4,01 cad  
 10  
 cm 3,8x10 mt



NASTRO TAPE STRAPPAL 4x14

172704  
 € 7,47 cad  
 24  
 cm 4x14 mt



NASTRO TAPE 5x10

550356  
 € 5,67 cad  
 10  
 cm 5x10 mt



NASTRO TAPE STRAPPAL 5x14

172705  
 € 9,78 cad  
 24  
 cm 5x14 mt



NASTRO TAPE 5x20

551025  
 € 8,06 cad  
 10  
 cm 5x20 mt



## BENDA COESIVA VISIOHAFT 10x4

Benda di fissaggio elastica coesiva  
Aderisce su se stessa e non  
sulla pelle, anallergica, permeabile  
all'aria  
Assolutamente antiscivolo  
Porosa ed assorbente, si adatta  
perfettamente ai contorni



163426

€ 7,20 cad

1

cm 10x4 mt

## TENSOPLAST 10x4,5

Benda elastica adesiva porosa  
ad alta traspirabilità.  
Indicata nel trattamento  
di patologie muscolari,  
tendinee ed articolari



715470

€ 16,66 cad

1

cm 10x4,5 mt

cotone - viscosa

## BENDA COESIVA VISIOHAFT 8x4

Benda di fissaggio elastica coesiva  
Aderisce su se stessa e non  
sulla pelle, anallergica, permeabile  
all'aria  
Assolutamente antiscivolo  
Porosa ed assorbente, si adatta  
perfettamente ai contorni



163419

€ 6,20 cad

1

cm 8x4 mt

## TENSOPLAST 7,5x4,5

Benda elastica adesiva porosa  
ad alta traspirabilità.  
Indicata nel trattamento  
di patologie muscolari,  
tendinee ed articolari



715460

€ 12,68 cad

1

cm 7,5x4,5 mt

cotone - viscosa

## BENDA COESIVA VISIOHAFT 6x4

Benda di fissaggio elastica coesiva  
Aderisce su se stessa e non  
sulla pelle, anallergica, permeabile  
all'aria  
Assolutamente antiscivolo  
Porosa ed assorbente, si adatta  
perfettamente ai contorni



163402

€ 5,20 cad

1

cm 6x4 mt

## TENSOPLAST 5x4,5

Benda elastica adesiva porosa  
ad alta traspirabilità.  
Indicata nel trattamento  
di patologie muscolari,  
tendinee ed articolari



715450

€ 9,80 cad

1

cm 5x4,5 mt

cotone - viscosa

## BENDA COESIVA PLUS

Benda elastica



161088

€ 4,25 cad

1

cm 6x2,5 mt

## SALVAPELLE SFUSO



550912

€ 3,44 cad

10

cm 7x27 mt



## COMPRESSE DI GARZA



140038

€ 2,90 cad

1

cm 10x10

## BENDA ELASTICA CON VELCRO

Polsiera / cavigliera

OUTLET  
fino al esaurimento scorte

150082

€ 5,00 cad

1

cm 8,50 x 90

## BENDE IDROFILE

3 bende in ogni scatola



150020

€ 2,60 cad

1

cm 7x3 mt

## BENDA ELASTICA

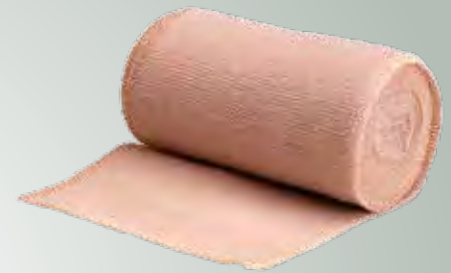
Fasciatura elastica  
+ 2 fermagli

150099

€ 2,70 cad

1

cm 8x5 mt

## TAMPONE NASALE

Per fermare il sanguinamento  
del nasoDeve essere introdotto  
molto lentamenteRiduce la pressione del sangue  
e ne blocca la fuoriuscita

135002

€ 14,34 cad

1

cellulosa naturale

## BENDA ALLA COLLA DI ZINCO

Pronta all'uso

L'alta percentuale di ossido di zinco sospesa in una soluzione di idrocolloide  
di origine vegetale ne fanno un prodotto ideale e sicuro che si caratterizza  
per la totale assenza di gelatine e derivanti animali.Questo fa sì che la benda, anche se conservata in luoghi caldi,  
mantenga tutte le sue proprietà senza perdere liquidi.

Indicata per distorsioni, lussazioni e fratture.



347150

€ 12,45 cad

1

cm 10x7 mt

## FORBICE UNIVERSAL

Forbice ricurva con impugnatura in plastica

La forma ricurva facilita il taglio dei tessuti

(abiti) di forti spessori

Acciaio inossidabile



020581

€ 9,28 cad

1

cm 19

acciaio e plastica

## FORBICE ACCIAIO

Da utilizzare per taglio bendaggi

Punta arrotondata

Professionale



034130

€ 12,92 cad

1

cm 18

acciaio inossidabile

## ACQUA OSSIGENATA



170011

€ 1,60 cad

1

ml 250

## KINETIC ROSA



BK164546

€ 11,70 cad

1

cm 5x5 mt

## COTONE IDROFILO

Cotone specifico per uso sanitario  
Trattato senza candeggianti  
e privo di fibre sintetiche



172100

€ 2,48 cad

1

gr 90

## KINETIC BLACK

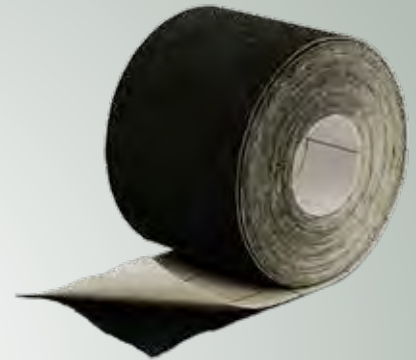

BK164539

€ 11,70 cad

1

cm 5x5 mt



La tecnica ha quattro principali effetti fisiologici:

### Corregge la funzione muscolare

Kinetic Tape è efficace nel ripristinare la giusta tensione muscolare: facilita o inibisce la contrazione muscolare (dipende dalla tecnica utilizzata).

### Aumenta la circolazione del sangue/linfa

Kinetic Tape aiuta ad eliminare l'eccesso di edema e/o emorragia tra la pelle ed il muscolo.

### Riduce il dolore

La soppressione neurologica del dolore avviene dall'applicazione del Kinetic Tape sulla zona colpita, e come menzionato nell'Effetto 2 (vedi sopra).

### Assiste nella correzione di allineamento dell'articolazione

La dislocazione di un'articolazione, dovuta alla tensione muscolare anormale, può essere corretta dal Kinetic Tape tramite il recupero della funzione e della fascia muscolare.

## KINETIC BLUE

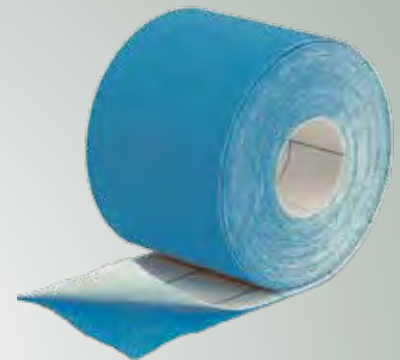

BK164515

€ 11,70 cad

1

cm 5x5 mt

## KINETIC FUXIA



BK164522

€ 11,70 cad

1

cm 5x5 mt

**GHIACCIO BUSTA Istantaneo**

Monouso



160920

€ 0,92 cad

25

**GHIACCIAIA GRANDE**

Pratico contenitore per ghiacci riutilizzabili  
Capacità 15 lt



112910

€ 78,40 cad

1

cm 38x26x37 h

**GHIACCIO SPRAY**

Con erogatore professionale



163297

€ 4,40 cad

6

ml 300

**INTEGRATORE BUSTA 330 GR**

Integratore di sali minerali e vitamina C  
E' un prodotto per sportivi destinato a reintegrare le perdite idrosaline dovute a profusa sudorazione  
Sciogliere il contenuto della busta in 5/6 litri d'acqua

Gusto limone



170933

€ 7,30 cad

1

gr 330

**GEL CALDO FREDDO + FASCIA**

Impacco caldo/freddo riutilizzabile  
Soffice e malleabile gelatina contenuta in un sacchetto di plastica a doppio strato  
Indicato per il pronto soccorso in caso di contusioni, strappi e traumi in genere



163983

€ 7,25 cad

1

**INTEGRATORE GR 10 ARANCIA**

Sciogliere il contenuto della busta in 150 ml d'acqua



182700

€ 0,77 cad

200

busta gr 10

**BORSA GHIACCIO**

Bocca larga



163358

€ 9,72 cad

1

cm 23

## CEROTTO STERILE

Nastro sterile  
per suture cutanee  
in tessuto non tessuto  
rinforzato



162511

€ 4,80 cad

1

cm 6x75 mm

## CEROTTI AQUASTOP

Resistenti all'acqua  
Alta protezione  
Strato in pura garza antiaderente  
Adesivo di ultima generazione



2 pezzi cm 7,5x7,5  
2 pezzi cm 7,5x10

112363

€ 2,15 cad

1

pu

OUTLET  
fino al esaurimento scorte

## ROCCHETTO TRASPARENTE



120214

€ 2,10 cad

12

cm 2,5x5 mt

## CEROTTO IN STRISCIA



110123

€ 2,10 cad

12

cm 6x1 mt

## CEROTTI IDROCOLLOIDALI PER VESCICHE

Cerotto idrocolloideale  
per la prevenzione  
e il trattamento  
delle vesciche  
Confezione da 5 cerotti



130312

€ 2,45 cad

12

cm 3,8x7

## CEROTTI CLASSICI

Strato di pura garza antiaderente  
Confezione da 20 cerotti



110024

€ 1,61 cad

1

cm 7x2

## KIT PRODOTTI MEDICALI PRIMO SOCCORSO

- 5 buste ghiaccio
- 1 ghiaccio spray
- 1 acqua ossigenata
- 1 cerotti classici
- 1 cerotto aquastop
- 1 cotone idrofilo
- 1 compresse di garza
- 1 bende idrofile
- 1 benda coesiva visiohaft 8x4



170800

€ 39,00 kit

1

**CREMA ARNICA**

Prodotto indicato per il trattamento rilassante della muscolatura e lenitivo articolare a base di arnica ad azione calmante. Ottimo dopo attività sportiva.



160006

€ 20,92 cad

1

ml 250

**OLIO PREGARA**

Ideale per garantire un intenso massaggio sportivo riscaldante, tonificante e stimolante sulla pelle prima di gare e allenamenti. Efficace sia a medie che a fredde temperature.

**OUTLET**  
 fino al esaurimento scorte

452379

€ 10,75 cad

1

ml 500

**PASTA SPASPASTE**

Pasta cremosa a base di fango marino ed essenze naturali. Riassorbente, rinfrescante e rafforzante. Si spalma per uno strato di circa 2mm sulla parte interessata e mantenuta per circa 6/8 ore. Si ottiene una migliore efficacia dei principi attivi usando un bendaggio non occlusivo.



171225

€ 21,84 cad

1

ml 250

**OLIO NEUTRO**

Olio molto scorrevole. Ideale per un massaggio fluido, energico e di lunga durata. Ad azione emolliente e purificante.

**OUTLET**  
 fino al esaurimento scorte

171850

€ 9,21 cad

1

ml 500

**GEL TRAUMAGEL**

Antidolorifico - Gel riattivante della circolazione a base di estratti naturali. Ottimo defaticante muscolare. Unito a SPASPASTE è particolarmente efficace per il riassorbimento rapido di ematomi e gonfiori causati da distorsioni e/o lesioni muscolari.



171325

€ 21,84 cad

1

ml 250

**OLIO PRESPOST RISCALDANTE**

Ideale per la preparazione all'attività sportiva.

**new**

191030

€ 13,86 cad

1

ml 300

**GEL RINFRESCANTE**

Gel rinfrescante che non irrita l'epidermide. Per ogni circostanza in cui siano necessari freddo e compressione. Ideale in casi di gonfiori e contusioni.



FRES25

€ 10,08 cad

1

ml 250

**CREMA PREGARA**

Crema ad azione riscaldante da applicarsi prima dell'attività sportiva. Consigliata per temperature ambientali medie e fredde. Si assorbe rapidamente ed ha un'azione impermeabilizzante.

**OUTLET**  
 fino al esaurimento scorte

171950

€ 9,21 cad

1

ml 500

## MASCHERA SALVANASO

Maschera di protezione per naso, zigomi e arcata sopraccigliare  
Misura universale



172300

€ 144,00 cad

1

misura unica

## PORTA BORSA GHIACCIO GINOCCHIO

Comodo e pratico supporto per reggere la borsa del ghiaccio



170500

€ 25,60 cad

1

misura unica

neoprene

## ROTOLO CARTA COPRI LETTINO

Rotoli di carta "doppio velo" di ottima qualità  
Resistente e con facilità di strappo  
Da utilizzarsi come lenzuolino per lettino



407564

€ 9,60 cad

6

cm 60x80 mt

pura cellulosa

## PORTA BORSA GHIACCIO SPALLA

Comodo e pratico supporto per reggere la borsa del ghiaccio



170600

€ 38,40 cad

1

misura unica

neoprene

## BARELLA PIEGHEVOLE

Portata 170 kg



034107

€ 225,72 cad

1

cm 201x48x14

	01	bianco	white
	02	giallo	yellow
	03	arancio	orange
	04	rosso	red
	05	granata	burgundy
	06	verde	green
	07	nero	black
	08	royal	royal
	09	blu	navy
	10	viola	violet
	11	celeste	sky blue
	20	giallo fluo	yellow fluo
	22	oro	gold
	30	arancio fluo	orange fluo
	60	verde fluo	green fluo
	70	grigio	grey
	40	fucsia	fuxia
	400	rosa	pink

### Listino

Il presente listino su catalogo annulla e sostituisce ogni precedente ed è in vigore dal 14 Giugno 2021. Nessuna Ns. responsabilità per eventuali errori tipografici dovuti alla stampa del presente listino su catalogo. Vi facciamo presente che il nuovo listino è da ritenersi suscettibile di riedizioni in funzione dei continui ed inaspettati aumenti dovuti alla situazione di mercato.

### Prezzi

I prezzi riportati nel presente catalogo sono al netto di IVA e si intendono per merce franco Ns. magazzino. **La ditta si riserva il diritto di apportare variazioni al presente listino senza alcun preavviso.** Ai clienti è riservata la modalità di pagamento concordata con la LEGAR entro la linea di fido concessa. Per i nuovi clienti le spedizioni arriveranno in contrassegno fino a quando non sarà costituita una linea di fido. I prezzi esposti si intendono cadauno, oppure per paio, kit o confezione dove specificato.

### Minimo d'ordine

Minimo d'ordine € 50,00.

Per **spedizioni** con importo inferiore, ci riserviamo il diritto di addebitare € 3,00 per spese di imballo.

**Pagamento con contrassegno contanti per importi inferiori a 100€**

### Spedizioni

Le spedizioni vengono eseguite franco nostro magazzino. **La merce viaggia a rischio e pericolo del committente, anche nel caso fosse venduta franco destino.** La LEGAR pertanto non è responsabile di eventuali ammanchi o danni di qualsiasi natura che si verificassero durante il trasporto e, tanto meno, è responsabile di eventuali ritardi dovuti al vettore. Tutte le spese derivanti da ritardato pagamento o mancato svincolo di merce regolarmente ordinata, saranno a carico del cliente inadempiente. Le spese di trasporto verranno addebitate in fattura. I corrieri sono scelti dalla LEGAR.

### Consegne

I termini massimi di consegna sono da intendersi approssimativi. In caso di interruzioni o impedimenti nella produzione non dovuti alla volontà della ditta LEGAR, la consegna di quanto non ancora prodotto verrà annullata senza che il compratore abbia diritto a richiedere alcun risarcimento, inoltre il compratore sarà tenuto comunque ad assolvere regolarmente al pagamento di quanto in precedenza consegnato.

### Modalità di Pagamento

I pagamenti dovranno essere effettuati al domicilio della LEGAR o a persone dalla stessa autorizzate. Il mancato pagamento delle fatture alle scadenze stabilite autorizza la LEGAR ad emettere note di addebito per interessi di mora nella misura pari al tasso bancario in vigore più spese generali pari a € 7,00. Inoltre si riserva di annullare la parte di fornitura non ancora eseguita e di richiedere l'immediato pagamento della parte già consegnata.

### Resi merce

Vi ricordiamo che per i resi merce è indispensabile attenersi alle seguenti modalità:

A) contattare i Ns. uffici o l'agente di zona e concordare l'autorizzazione al reso;

B) effettuare il reso in porto franco a mezzo corriere;

C) il soggetto che effettua la restituzione dei beni deve emettere:

DDT con causale: "reso merce", specificando nello stesso gli estremi della fattura acquisto dei beni restituiti.

Se non saranno osservate queste disposizioni LEGAR non potrà emettere la nota di accredito.

Non saranno presi in considerazione resi di merce effettuati dopo un anno dall'acquisto.

Non potranno essere accettati resi di merce, reclami, richieste di sostituzione o rimborsi, per gli articoli manomessi, stampati o personalizzati.

### Controversie

Per tutte le controversie che non possono essere risolte amichevolmente il tribunale competente è il foro di Brescia.



The page contains 20 horizontal dotted lines for writing. A light gray wavy graphic is positioned on the left side, starting from the middle of the page and extending towards the top right corner.

A series of horizontal dotted lines for writing, with a light gray curved graphic element in the middle.

The page contains 20 horizontal dotted lines for writing. A light gray, wavy, semi-transparent graphic element is positioned on the right side of the page, starting from the top right and curving downwards towards the middle of the page.





LEGAR SPORT S.R.L.